

SB Brace Frame

Reliable load transfer for single-sided forming operations up to 8.75 m high

Product Brochure – Issue 09/2018

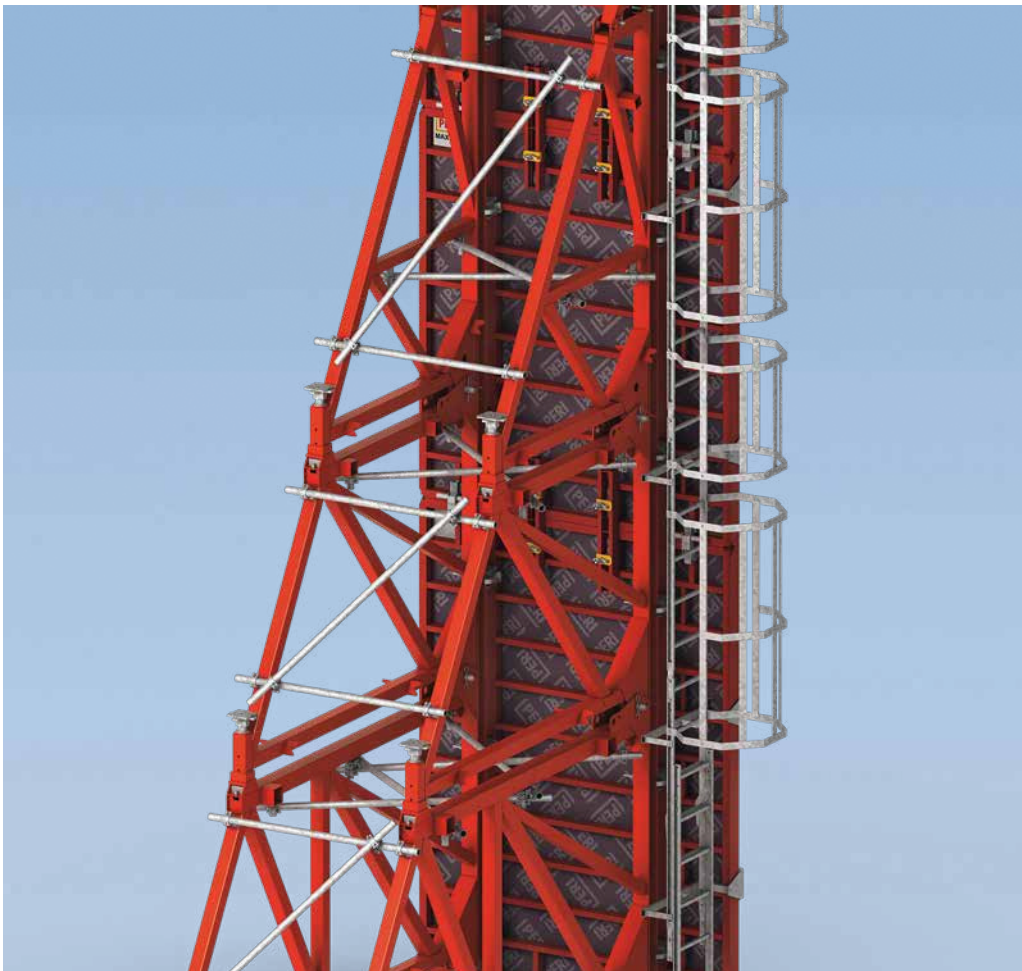

Content

System Advantages		System Overview	
5	The SB Brace Frame – reliable load transfer for single-sided forming operations up to 8.75 m high	14	The brace frame system at a glance
6	Quickly extended without any additional parts, as all required connection parts are already mounted on the Brace Frame	Standard Applications	
10	Versatile use with all PERI wall formwork systems	16	Connecting to system formwork
12	Can be used horizontally as working platforms up to 8.75 m wide	18	Anchor systems
		20	Simple and accurate anchor installation
		System Supplements	
		22	Simple logistics
		23	The SCS Brace Frame as a further single-sided solution

Issue 09/2018

Publisher

PERI GmbH
Formwork Scaffolding Engineering
Rudolf-Diesel-Strasse 19
89264 Weissenhorn
Germany
info@peri.com
www.peri.com

Components

24 SB Brace Frame system components

Important information

All current safety regulations and guidelines applicable in those countries where our products are used must be observed.

The photos shown in this brochure feature construction sites in progress. For this reason, safety and anchor details in particular cannot always be considered as conclusive or final. These are subject to the risk assessment carried out by the contractor.

In addition, computer graphics are used, which are to be understood as system representations. To ensure a better understanding, these and the detailed illustrations shown have been partially

reduced to show certain aspects. The safety installations that may not be shown in these illustrations must nevertheless still be available. Please note that the systems or items shown might not be available in every country.

Safety instructions and load specifications are to be strictly observed at all times. Separate structural calculations are required for any deviations from the standard design data.

The information contained herein is subject to technical changes in the interests of progress. Errors and typographical mistakes reserved.

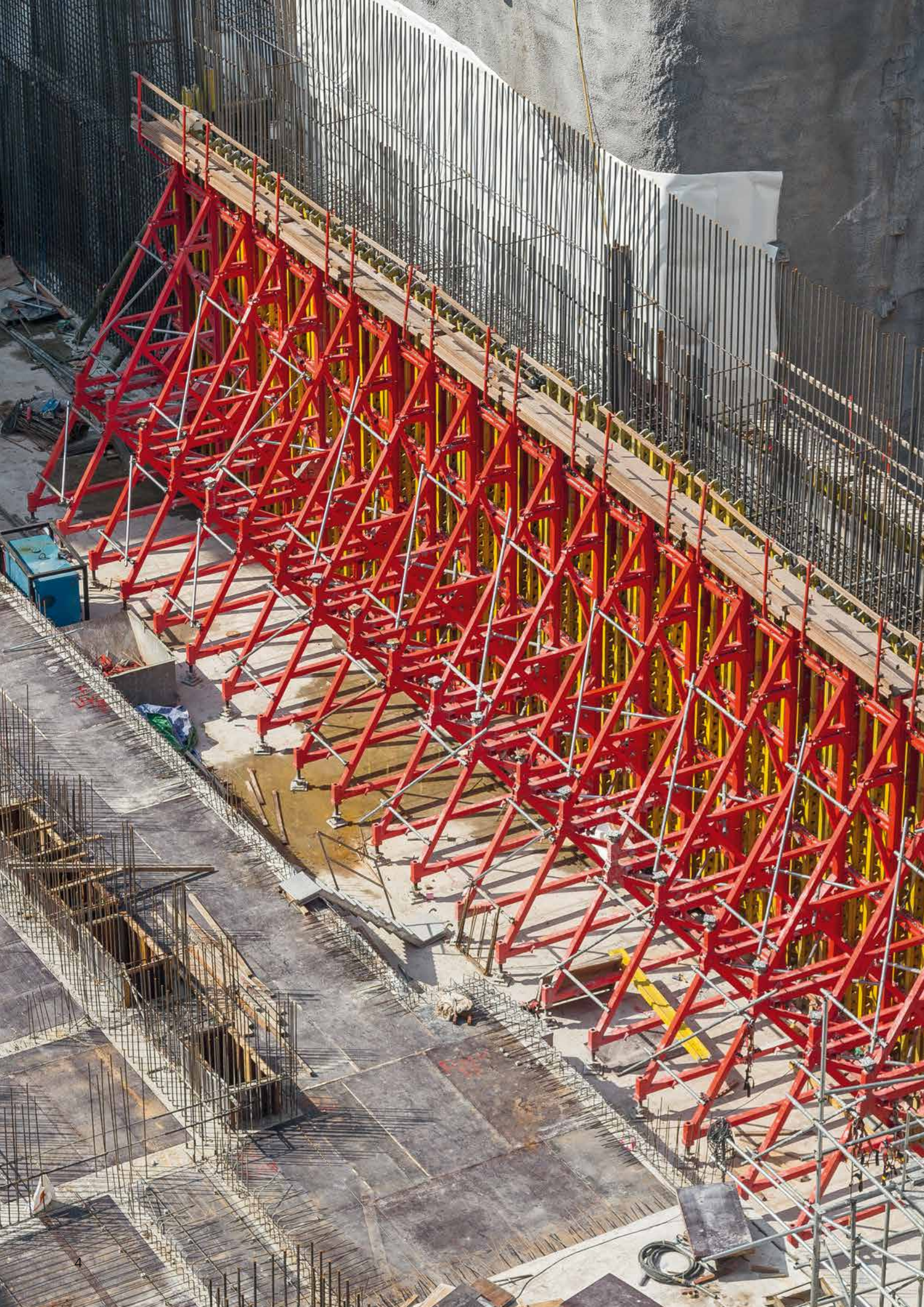

The SB Brace Frame

Reliable load transfer for single-sided forming operations up to 8.75 m high

SB Brace Frames transfer the fresh concrete pressure into the sub-structure and foundations during single-sided concreting of components. In addition, they can be used as horizontal heavy-duty brackets.

When carrying out single-sided concreting operations against existing walls, rock or sheet piling, the full fresh concrete pressure exerted on the surface of the formwork must be transferred to the sub-structure, through a suitably anchored brace frame con-

struction. PERI Brace Frames have been designed for concreting heights of up to 8.75 m and a fresh concrete pressure of maximum 60 kN/m².

The brace frame system consists of three versions. The Brace Frames SB-A0, A, B and C can be used individually or in combination to accommodate different heights. They can be extended modularly up to 8.75 m in height using bolts and cotter pins. Using a standard configuration, the SB-2 Brace Frame can be used up to a maximum concreting height of 6.00 m. For forming sin-

gle-sided walls of up to 3.00 m concreting heights, the SB-L Brace Frame can be used without a crane. It is assembled on-site using standard components.

All Brace Frame frames can be quickly and easily connected to all PERI formwork systems. Through a corresponding assembly of scaffold tubes, the Brace Frame can be adapted to match the formwork regarding the width of influence. All individual components are sized to conform with truck or container transport requirements.

Quickly extended without any additional components

as all required connection parts are already mounted on the Brace Frame unit

Extremely versatile use

with all PERI wall formwork systems

Can be used horizontally

as working platforms up to 8.75 m wide

Quickly extended without any additional components

as all required connection parts are already mounted on the Brace Frame

The modular structure is a big advantage. Brace Frames can be extended up to 8.75 m high and are easily connected using bolts and cotter pins.

All required connection parts are already mounted on each Brace Frame. When extending, no further additional parts are needed; a hammer is the only tool required.



For lower concreting heights of 4.00 m, the frames of Brace Frames SB-A and SB-C can be combined.



When concreting single-sided against existing sheet piling, the entire fresh concrete pressure is transferred into the sub-structure via the Brace Frame complete with corresponding anchorage.



Through a corresponding assembly of scaffold tubes, the Brace Frame can be adapted to match the formwork regarding the width of influence.



Quickly extended without any additional components as all required connection parts are already mounted on the Brace Frame

Due to the modular combination of the Brace Frame frames, concreting heights of up to 8.75 m are possible. When extending, only bolts and cotter pins are needed, which are mounted on the Brace Frame.

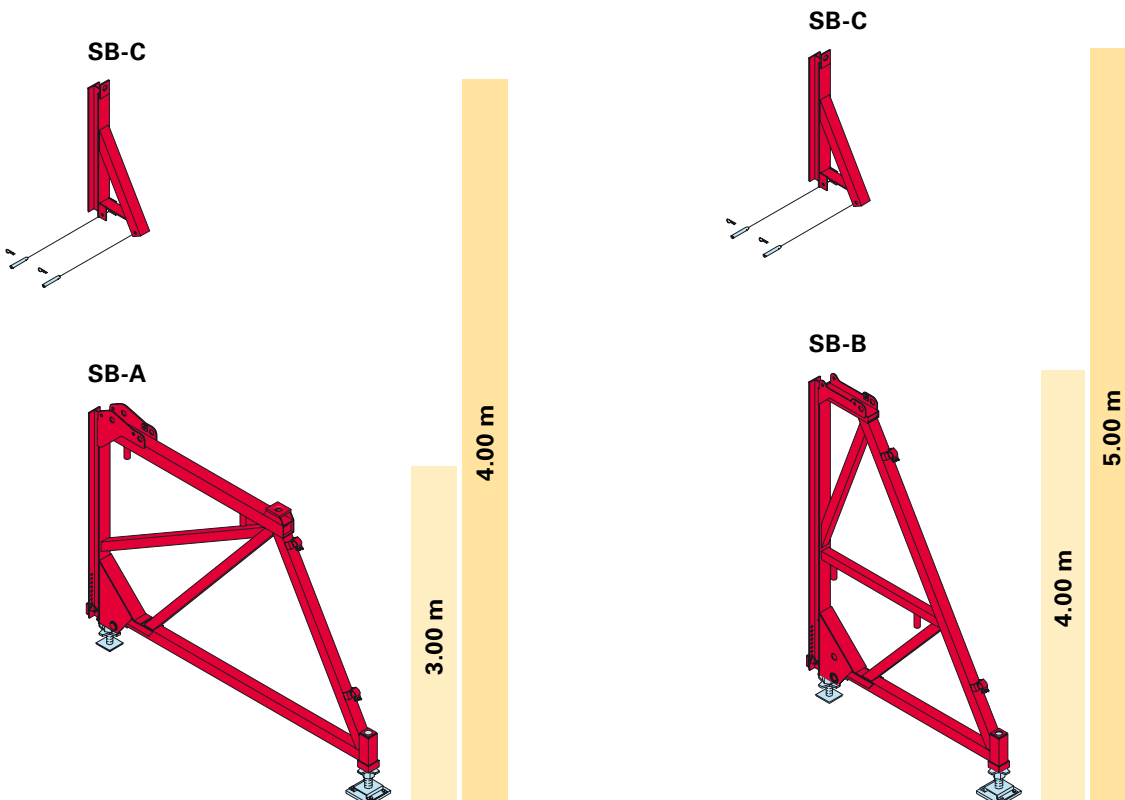

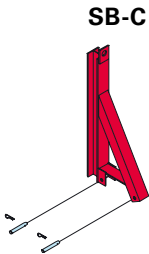

SB-C

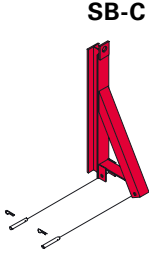

SB-C

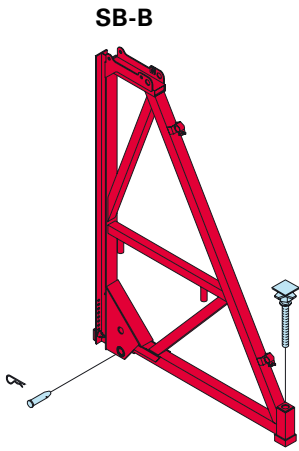

SB-B

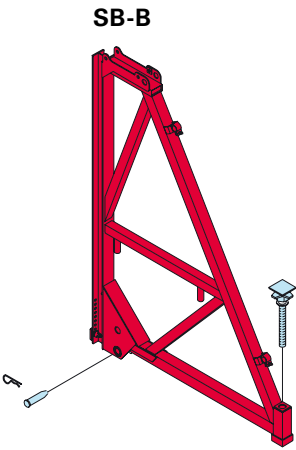

SB-B

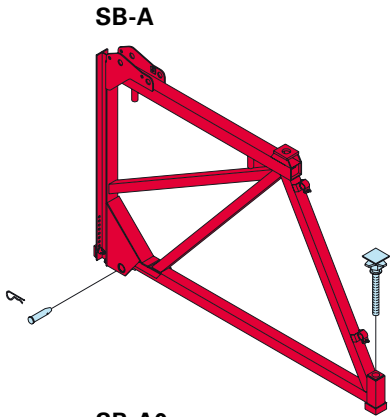

SB-A

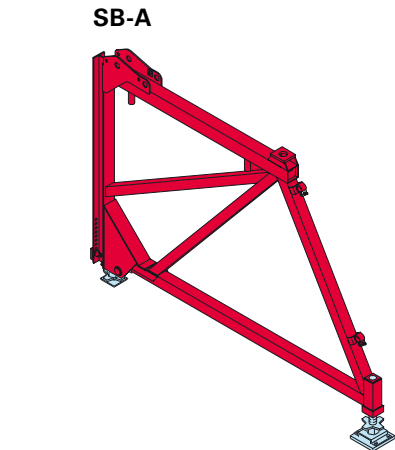

SB-A

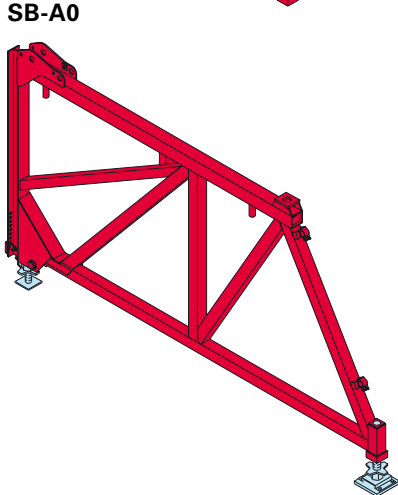

SB-A0

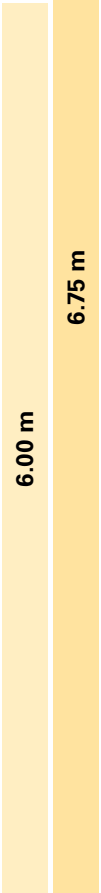

6.00 m

6.75 m

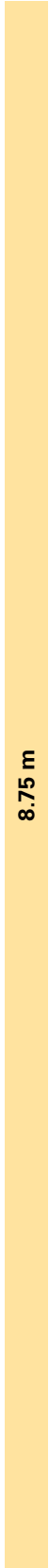

8.75 m

Extremely versatile use with all PERI wall formwork systems

The SB-A0, A, B and C brace frames are designed with a strong European IPB wide flange beam section on the front which allows forces to be transferred to them at all points. Thereby, the selection of formwork panels for MAXIMO, TRIO, DOMINO or the position of the steel walers with VARIO GT 24 and RUNDFLEX is not an issue. The Brace Frames can be combined with PERI wall formwork systems using system connection parts.

Brace Frames are assembled on the panels positioned horizontally on the ground. A crane is always required for mounting the Brace Frame on the formwork. The nature of the connection allows them to be lifted as a single unit.



The formwork support connects Brace Frames SB-A0, A, B, C with the MAXIMO, TRIO or DOMINO formwork systems.

The RUNDFLEX-Brace Frame connection is realised using a waler connector and wedge, just like the VARIO GT 24 Girder Wall Formwork.



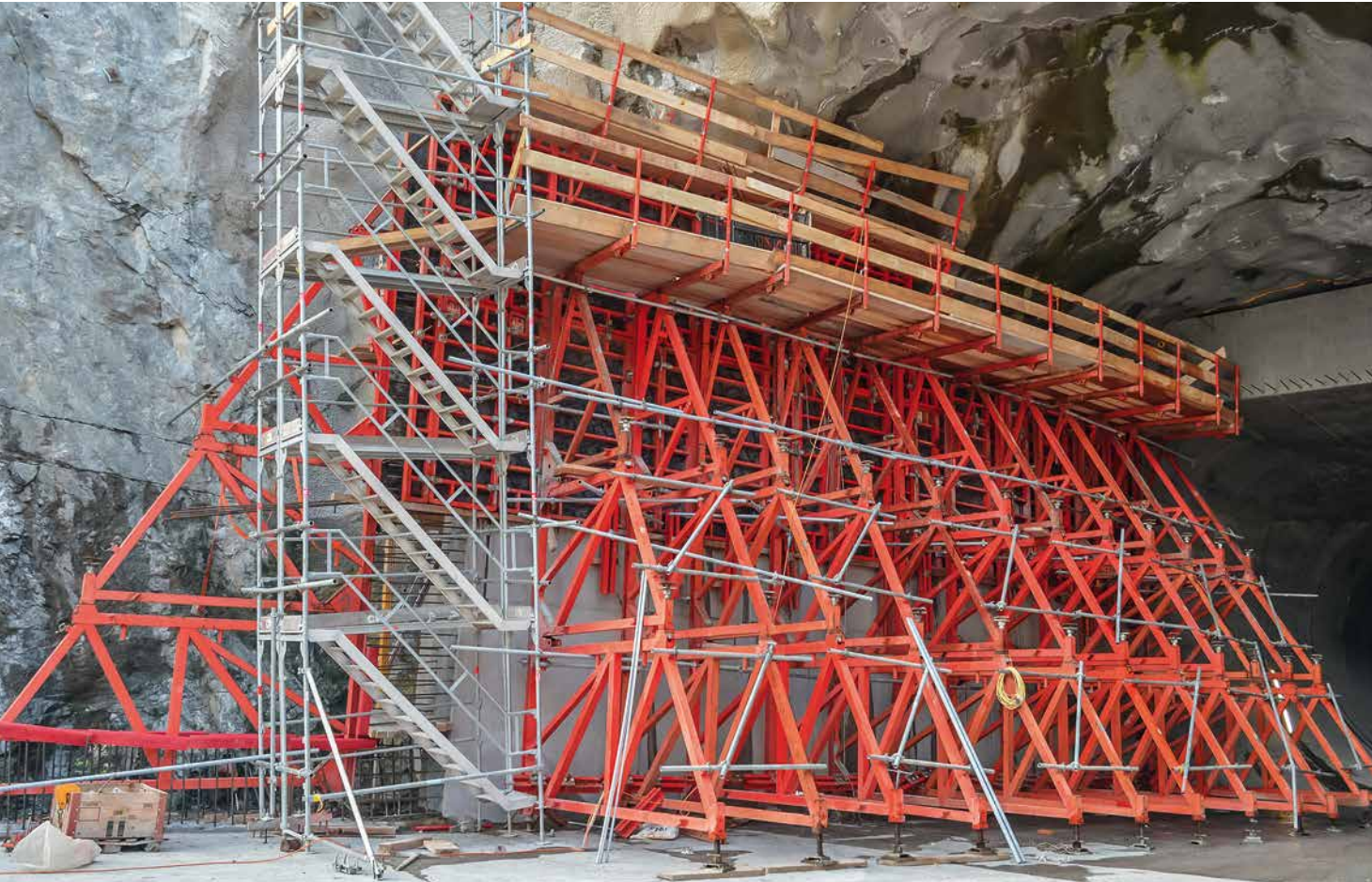

Force is safely and reliably transferred at all connection points of the SB-A0, A, B and C.

For single-sided concreting, the Brace Frame transfers the high loads into the foundations.

The required working platforms are correspondingly attached to the respective formwork system.



Can be used horizontally

as working platforms up to 8.75 m wide



The Brace Frames can also be used as horizontal heavy-duty brackets. This application allows the formation of larger working platforms of up to 8.75 m wide, whilst simultaneously accommodating high shear forces.

The large shear and tensile forces are transferred into the concrete via the building-approved PERI Climbing Cone-2 M36/DW 26.

Similar to crane-climbed systems, Brace Frame Brackets can be safely and easily hooked onto climbing cones by means of Scaffold Mounting Rings.



The connectable Brace Frames can be used horizontally as a load-bearing bracket construction.



The spacing and number of Brace Frame Sections are determined through the existing load.

For use as a horizontal heavy-duty bracket, two different suspension methods are available:

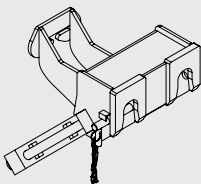

1. Double suspension with Wall Scaffold Hinge SB double

For the SB-A0, A and B systems, the permissible shear force for the Brace Frame Wall Scaffold Hinge-2 is 200 kN.

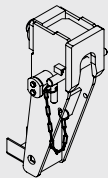

2. Single suspension with Wall Scaffold Hinge SB

For Brace Frames SB-A0, A, B and SB-2, the permissible shear force for the Brace Frame Wall Scaffold Hinge is 120 kN.



Horizontally mounted Brace Frame system combined with system components of the VARIOKIT Engineering Construction Kit form cantilevered working platforms.



Brace Frames and system components taken from the VARIOKIT Engineering Construction Kit form large-sized platforms up to 8.75 m wide.



Horizontally positioned Brace Frames could replace high shoring structures for slab cantilevers.

The Brace Frame system at a glance

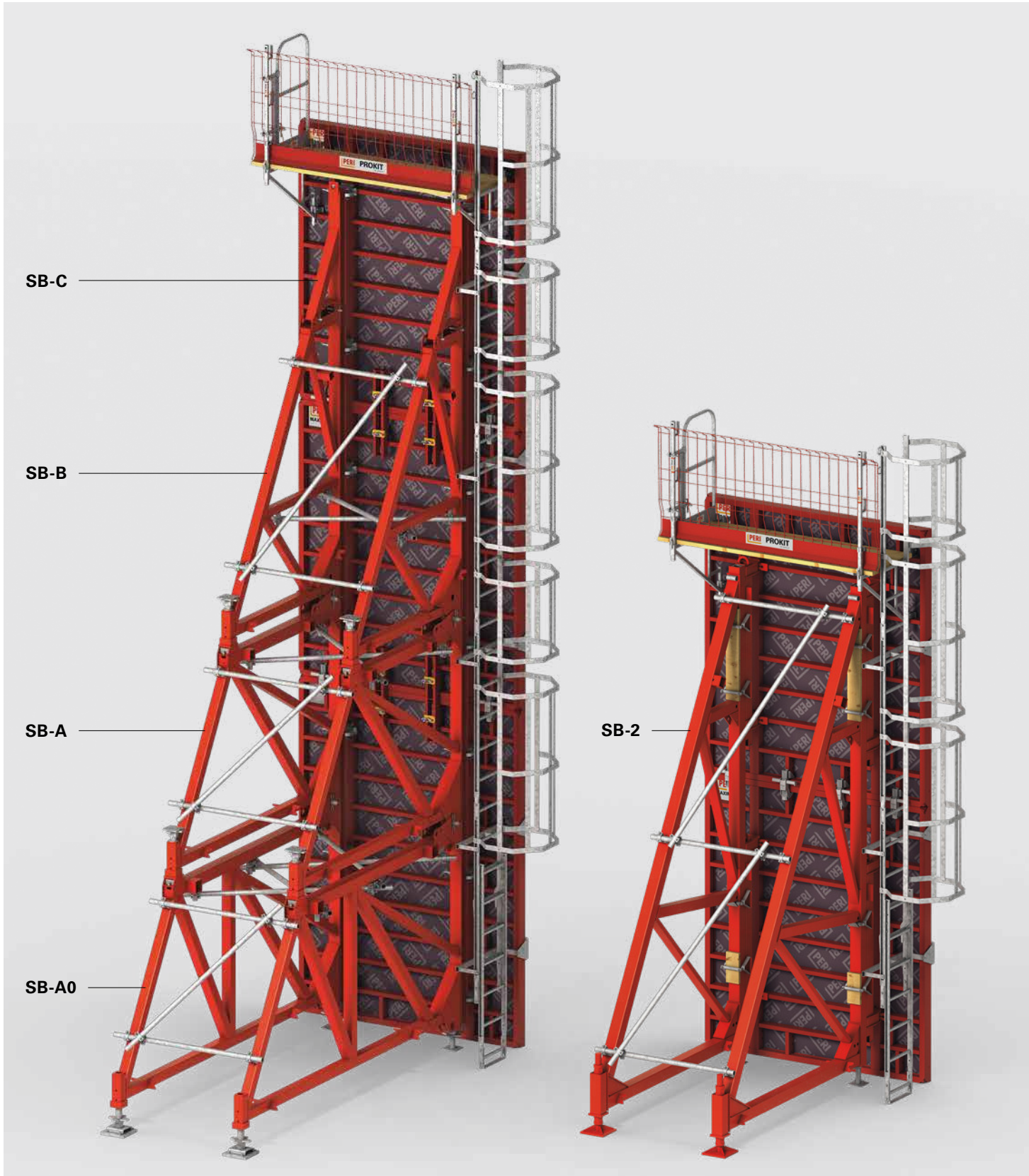



The Brace Frame system consists of three versions. The Brace Frames SB-A0, A, B and C can be used individually or in combination to accommodate different heights. They can be extended modularly up to 8.75 m in height using bolts and cotter pins.

Using a standard configuration, the Brace Frame SB-2 can be used up to a maximum concreting height of 6.00 m.

For forming single-sided walls of up to 3.00-m concreting heights, the Brace Frame SB-L can be used without a crane. It is assembled on-site using standard components.

Connecting to system formwork

Connection to girder formwork with Waler Connector and Wedge

For mounting the Brace Frame on VARIO GT 24 Girder Wall Formwork with a maximum concreting height of 8.75 m or on RUNDFLEX Circular Formwork with a maximum concreting height of 8.40 m, one waler connector and one wedge are used per waler line.

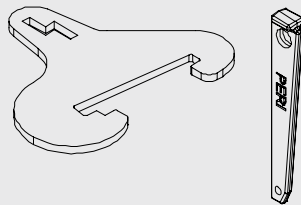

Waler Connector and Wedge for connecting Brace Frame SB-A, B, C to girder formwork.

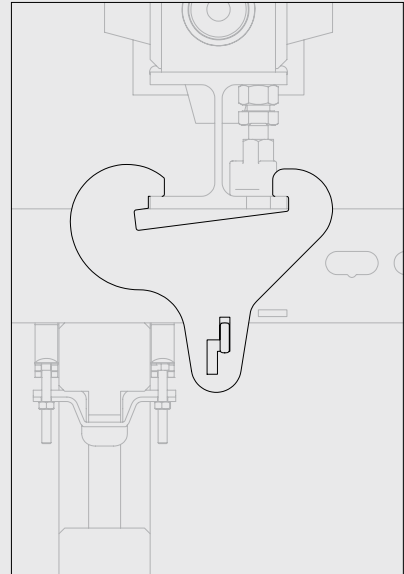

Connection to panel formwork with Brace Frame connection and bolts

For mounting the Brace Frame to panel formwork such as MAXIMO, TRIO or DOMINO with a maximum vertical concreting height of 8.75 m or 8.40 m horizontally, one Connector SB and one bolt are used per waler line / anchor point. For MAXIMO panel formwork, a sleeve is additionally inserted into the anchor holes.

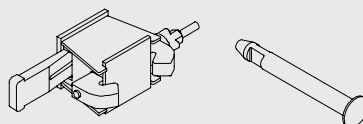

Connector SB-A, B, C-MX/TR/D Bolt Ø 19x165

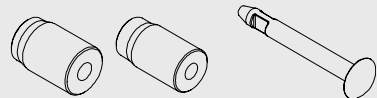

Sleeve SB-MAXIMO and SB-MAXIMO WDMX for removable sealings Bolt SB-MAXIMO

Connection to DUO Universal Formwork with Hook Strap SB DUO

For mounting the Brace Frame on the DUO Universal Formwork with a maximum concreting height of 5.40 m, the Hook Strap SB DUO is used in combination with the Compensation Waler DUO.

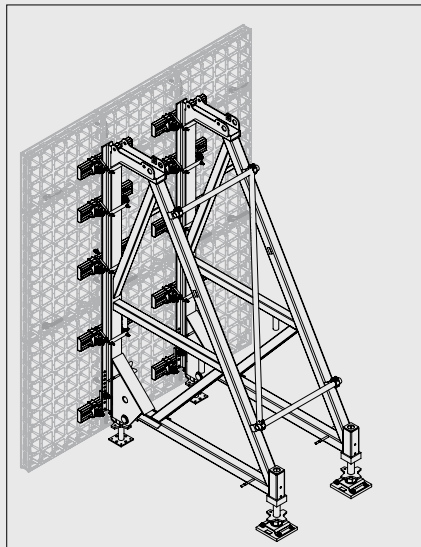

The Brace Frames are fixed at vertical joint positions of the panels mounted on the Compensation Waler DUO.

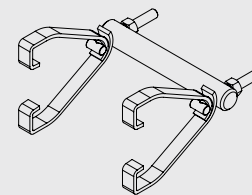

Hook Strap SB DUO for mounting the Brace Frame SB to the Compensation Waler DUO.

For mounting the Brace Frame SB-2 on girder wall formwork, one Hook Strap is required for each waler line. For fixing to the steel walers, the Hook Strap SB-1, 2 or Hook Strap SB-2 can be used asymmetrically.

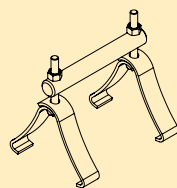

Hook Strap SB-1, 2

For mounting the Brace Frame SB-2 to MAXIMO, TRIO or DOMINO panels, a Connector is first fixed to the anchor holes. The Brace Frame can subsequently be connected to the lugs of the Connector by means of Hook Straps SB-1, 2.

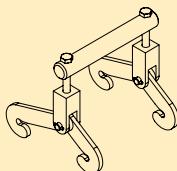

Hook Strap SB-2, asymmetric

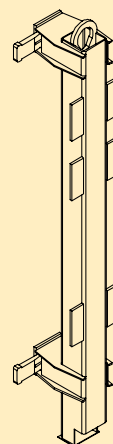

Connector SB-1, 2 - MX/TR/D

Anchor systems

Connection to PERI formwork systems is realised using corresponding connection parts. There are three different anchor systems for tensile anchoring of the occurring forces in the ground.

The choice of anchoring system is determined by the tensile force Z applied on the Brace Frame.

Depending on the anchor system used, a Double Anchor Tie Yoke or Anchor Waler is used.

Anchor system	perm. anchor forces
DW 15	90 kN
DW 20	150 kN
DW 26	250 kN

Anchoring is always carried out using 2 anchors per Brace Frame so that, e.g. when using the DW 20 system, a maximum tensile force of $2 \times 150 = 300$ kN may be allowed.

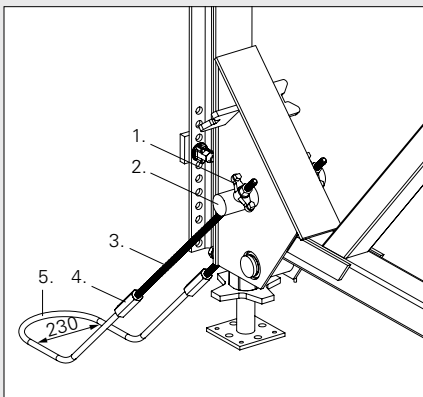
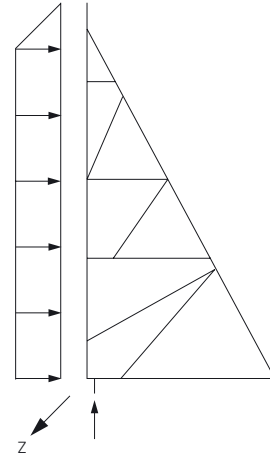

Tie System DW 15

in the execution with Double Anchor Tie Yoke
Permissible tension force 2×90 kN = 180 kN

1. Wingnut DW 15
2. Double Anchor Tie Yoke
3. Tie Rod DW 15
4. Hex. Nut DW 15 SW 30/108
5. Brace Frame Double Anchor DW 15

Alternatively with Tie Rod DW 15 with Threaded Anchor Plate DW 15

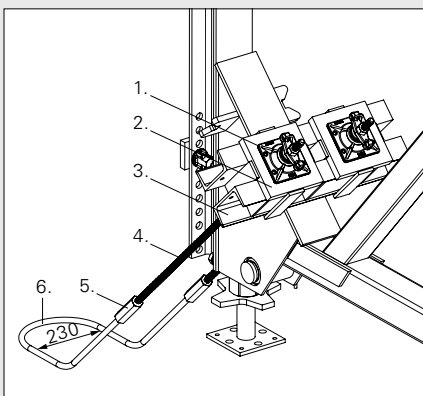

Tie System DW 15

in the execution with Anchor Waler
Permissible tension force 2×90 kN = 180 kN

1. Wingnut Pivot Plate DW 15
2. Anchor Plate SB DW 26
3. Anchor Waler U140, 0.55 m or Anchor Waler U140, 2.35 m
4. Tie Rod DW 15
5. Hex. Nut DW 15, SW 30/108
6. Brace Frame Double Anchor DW 15

Alternatively with Tie Rod DW 15 with Threaded Anchor Plate DW 15



Particular attention must be paid to the following when using the Brace Frames.

The structural members (e.g. foundations or ground slabs) must be able to accommodate the tension and compression forces which occur. Check their design and anchor positioning before concreting.

The "other side" of the single-sided formwork (existing walls, planking, rocks etc. must naturally be able to withstand the fresh concrete pressure acting upon it.

DW Tie Rods installed for anchoring purposes must not be welded or bent. When using other anchors or formwork systems, the possible applications as well as stability must be checked separately by the user.

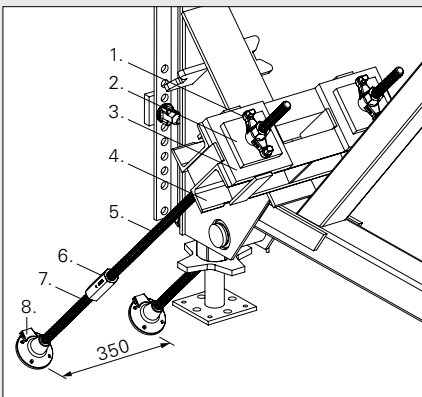

Tie System DW 20

in the execution with Anchor Waler
Permissible tension force $2 \times 150 \text{ kN} = 300 \text{ kN}$

1. Wingnut DW 20
2. Counterplate DW 20, 120 x 120 x 20
3. Anchor Plate SB DW 26
4. Anchor Waler U160, 0.55 m
5. Tie Rod DW 20
6. Hex. Nut DW 20, SW 36/110
7. Tie Rod DW 20
8. Threaded Anchor Plate DW 20

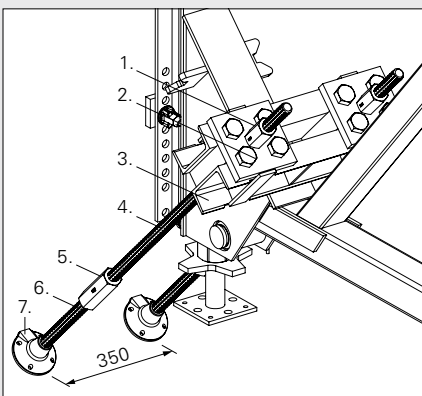

Tie System DW 26

in the execution with Anchor Waler
Permissible tension force $2 \times 250 \text{ kN} = 500 \text{ kN}$

1. Hex. Nut DW 26, SW 46/80
2. Tension Release Plate SB DW 26
3. Anchor Waler U160, 0.55 m
4. Tie Rod DW 26
5. Hex. Nut DW 26, SW 46/150
6. Tie Rod DW 26
7. Threaded Anchor Plate DW 26

Simple and accurate anchor installation

With the PERI V-Tie Holder and Leading Anchor Coupler, accurate assembly of the Tension Anchor under 45° is possible. This ensures safe and reliable transfer of loads and, thus, maximum stability of the Brace Frame and formwork.

The economic advantages of the anchoring system with the V-Tie Holder and Leading Anchor Coupler are:

- Only a small number of coupling nuts have to be stocked
- No need to cut tie rods off
- Tie rods are recoverable

Work sequence for lost tie rods

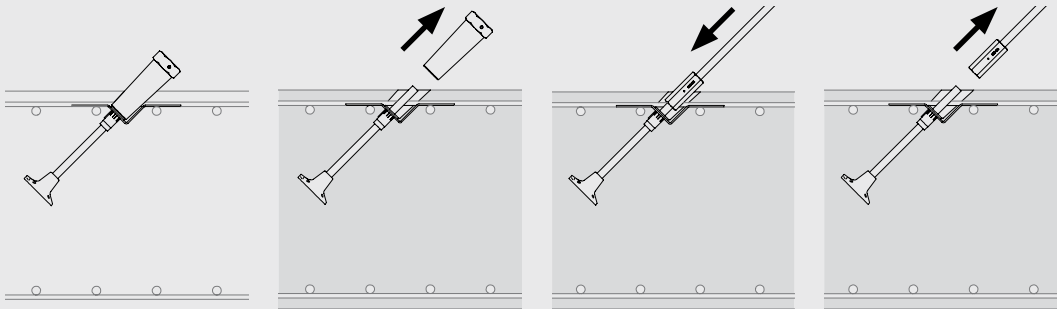

Before concreting, the V-Tie Holder together with Tie Rod, Threaded Plate and Leading Anchor Coupler are installed in the reinforcement.

After concreting, the Leading Anchor Coupler can be removed using the Spanner SW 70, and then re-used.

After the tie rod has been checked to ensure that it has been correctly fitted, the hex. nut and tie rod are securely fixed to the Brace Frame by means of the spanner.

When dismantling the Brace Frame, the tie rod and hex. nut are unscrewed with the spanner and the remaining hole is subsequently filled.

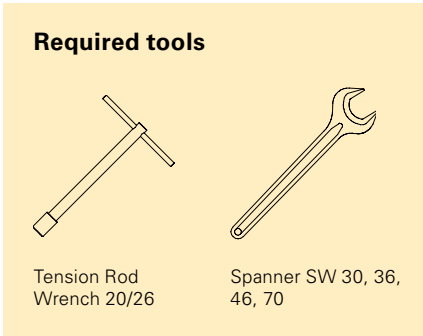

With the V-Tie Holder, as a lost part, an exact alignment of the Tension Anchor to 45 ° is possible.



The Leading Anchor Coupler can be recovered after concreting.

Work sequence for re-usable tie rods

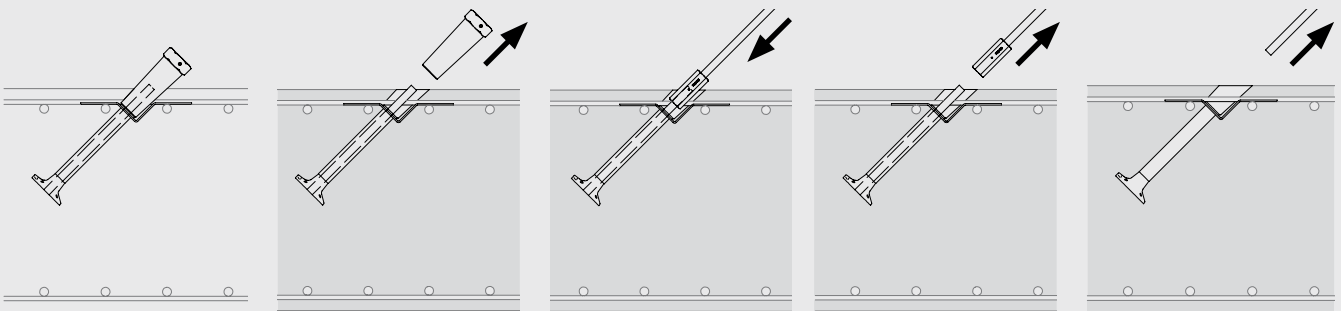

Before concreting, the V-Tie Holder, the Spacer Tube rough, Threaded Plate, tie rod and the Leading Anchor Coupler are all installed in the reinforcement.

After concreting, the Leading Anchor Coupler can be removed using the Spanner SW 70, and subsequently be re-used.

After the tie rod has been checked to ensure that it has been correctly fitted, the hex. nut and tie rod are securely fixed to the Brace Frame using the spanner.

When dismantling the Brace Frame, the tie rod and hex. nut are unscrewed with the spanner.

The tie rod can be removed using the Tension Rod Wrench and re-used. The remaining hole is subsequently filled.

Simple logistics

Brace Frames can be moved as units, consisting of 2 Brace Frames including the formwork, with the crane using the suspension points provided for this purpose.

With the guide roller, the Brace Frame unit can be moved slowly without the help of any power-operated pulling means. The guide roller is simply pushed over the profile tube and secured with a wedge.

Diagonal bracing is required when moving the Brace Frame and aligning the formwork unit with the crane.

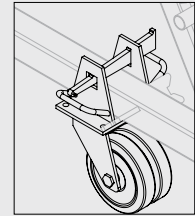
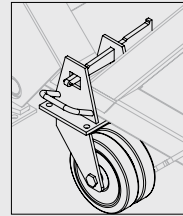

All individual components are sized to conform with truck or container transport requirements. Depending on the truck, 6 Brace Frames can be transported as one stack - 10 frames can be stacked when using the Brace Frame SB-C.

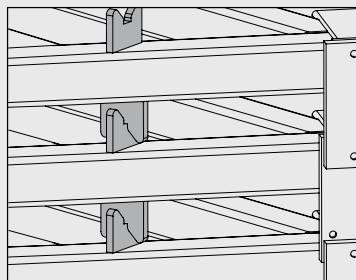

With the help of the integrated stacking aid, Brace Frames of the same size can be transported in one stack.

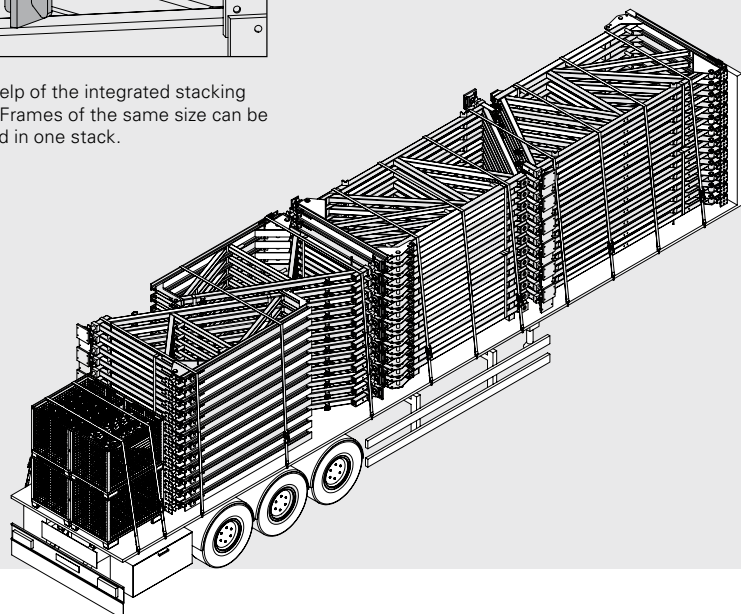

The Brace Frame SCS as a further single-sided solution



The Brace Frame SCS is a modular construction consisting of Strongbacks, Heavy-Duty Spindles and Starter Wallers. For the first casting segment of the SCS Climbing System, a Starter Brace Frame is used while diagonal anchoring transfers the loads into the bottom slab.

The SCS Starter Brace Frame is designed in such a way that the Strongback, Spindle and formwork can also be used in the next casting segments with the climbing bracket.

With SCS, inclined starters can also be realised as the inclination of the wall is adjusted using the Heavy-Duty Spindle.

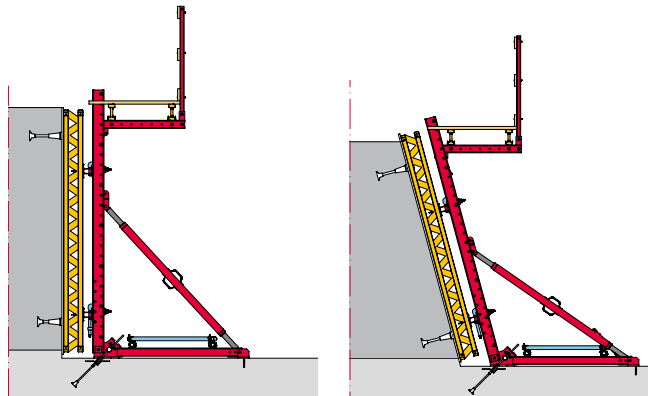

SB Brace Frame



Item no.	Weight kg
025690	412.000

Brace Frame SB-A0

For forming single-sided walls and special applications.

Complete with

- 1 pc. 700555 Rear Base Spindle for SB
- 1 pc. 700554 Adjusting Nut SB-A0/A/B
- 1 pc. 025730 Spindle TR 60 x 9/43
- 1 pc. 710545 Bolt Ø 50 x 150, galv.
- 1 pc. 710618 Cotter Pin 8, galv.
- 2 pc. 017040 Screw-On Coupler AK 48, galv.
- 1 pc. 700553 Adapter
- 1 pc. 030130 Cam Nut DW 15, galv.

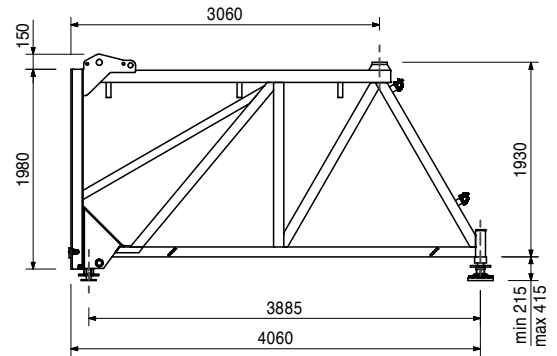
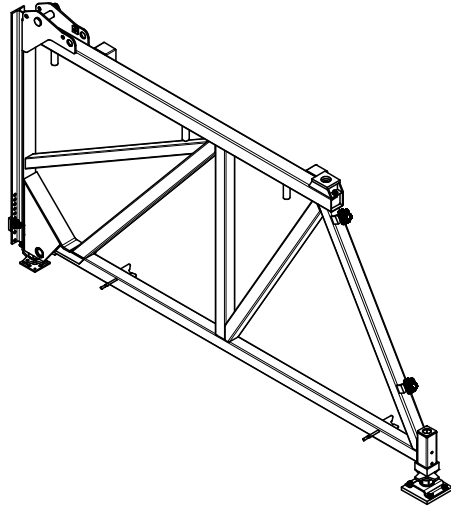

Accessories

027210	3.300
--------	-------

Spanner SW 80, for SB

025700	325.000
--------	---------

Brace Frame SB-A

For forming single-sided walls and special applications.

Complete with

- 1 pc. 700555 Rear Base Spindle for SB
- 1 pc. 700554 Adjusting Nut SB-A0/A/B
- 1 pc. 025730 Spindle TR 60 x 9/43
- 2 pc. 017040 Screw-On Coupler AK 48, galv.
- 1 pc. 700553 Adapter
- 1 pc. 030130 Cam Nut DW 15, galv.

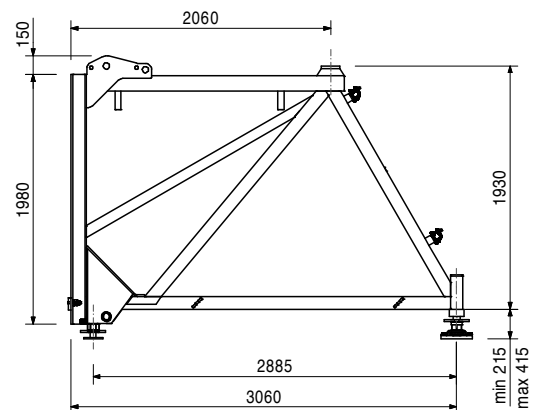
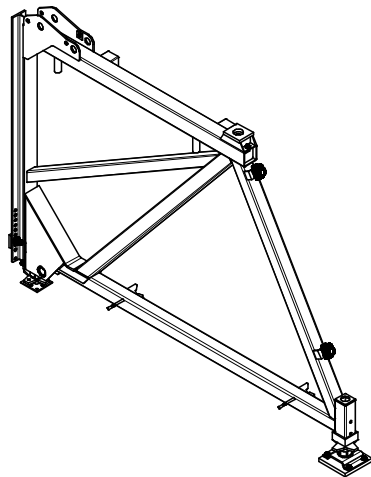

Accessories

027210	3.300
--------	-------

Spanner SW 80, for SB

SB Brace Frame

Item no.	Weight kg
025710	276.000

Brace Frame SB-B

For forming single-sided walls and special applications.

Complete with

- 1 pc. 700555 Rear Base Spindle for SB
- 1 pc. 700554 Adjusting Nut SB-A0/A/B
- 1 pc. 025730 Spindle TR 60 x 9/43
- 1 pc. 710545 Bolt Ø 50 x 150, galv.
- 1 pc. 710618 Cotter Pin 8, galv.
- 2 pc. 017040 Screw-On Coupler AK 48, galv.
- 1 pc. 700553 Adapter
- 1 pc. 030130 Cam Nut DW 15, galv.

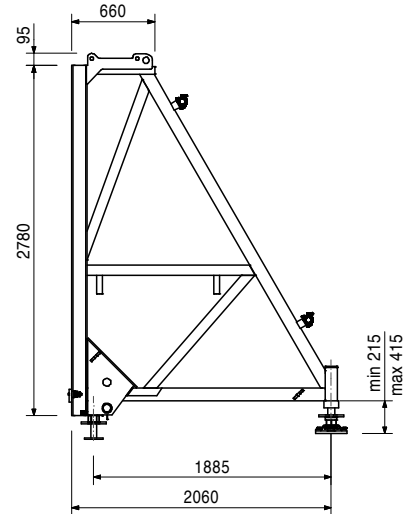
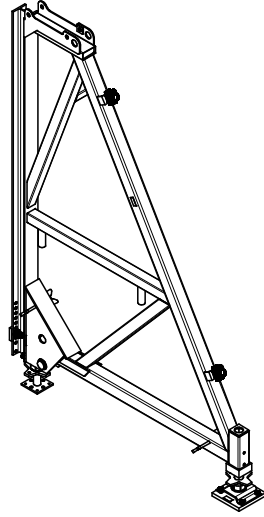

Accessories

027210	3.300
--------	-------

Spanner SW 80, for SB

025720	49.900
--------	--------

Brace Frame SB-C

For forming single-sided walls and special applications.

Complete with

- 2 pc. 715936 Pin Ø 25 x 180, incl. dowel pin Ø 6
- 2 pc. 018060 Cotter Pin 4/1, galv.

Technical Data

Permissible load-bearing point capacity
 1.5 t with crane sling angle $\leq 15^\circ$,
 2.5 t with vertical lift.

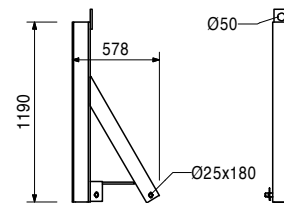
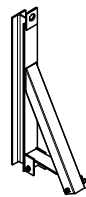

SB Brace Frame

Item no.	Weight kg
027690	0.368

Bolt SB-TRIO/DOMINO, galv.
For panel formwork with 12 cm overall thickness.

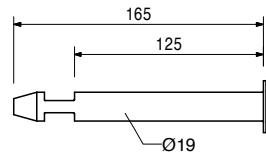
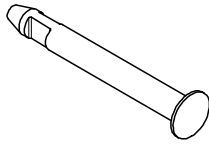

Accessories

114107	1.190
114417	1.400

Sleeve SB-MAXIMO, galv.
Sleeve SB-MAXIMO WDMX

113255	0.414
--------	-------

Bolt SB-MAXIMO, galv.
For connecting MAXIMO Panels with Brace Frame SB.

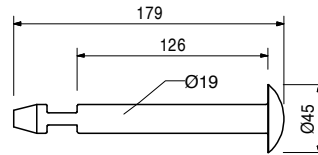
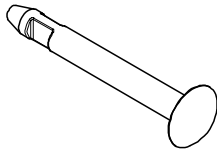

Accessories

114107	1.190
114417	1.400

Sleeve SB-MAXIMO, galv.
Sleeve SB-MAXIMO WDMX

114107	1.190
--------	-------

Sleeve SB-MAXIMO, galv.
For connecting MAXIMO Panels with Brace Frame SB.

Note
For use with Sealing Sleeve MX Ø 16 item-no. 112342 and Nut Sealing Sleeve MX Ø 16 item-no. 112338.

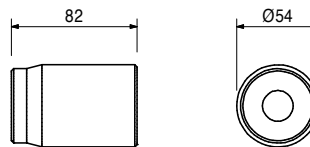
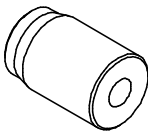

Accessories

113255	0.414
114417	1.400

Bolt SB-MAXIMO, galv.
Sleeve SB-MAXIMO WDMX

114417	1.400
--------	-------

Sleeve SB-MAXIMO WDMX
For connecting MAXIMO Panels to Brace Frames SB.

Note
For use with Sealing Sleeve MX 15 item-no. 123603 and Sealing Sleeve MX 18 item-no. 123604.

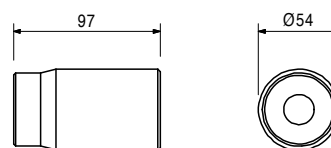
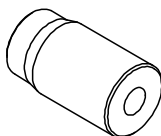

Accessories

113255	0.414
--------	-------

Bolt SB-MAXIMO, galv.

SB Brace Frame

Item no.	Weight kg
025740	9.140

Connector SB-A, B, C - MX/TR/D
 For connecting MAXIMO, TRIO and DOMINO Panels with Brace Frames SB-A0, A, B, C.

Note
 1 piece per anchor point.

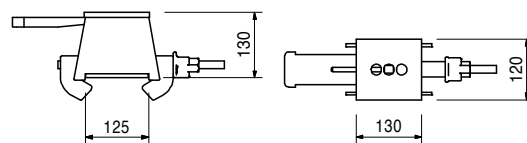
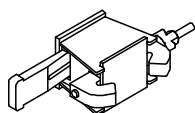

Accessories

027690	0.368
113255	0.414
114107	1.190
114417	1.400

Bolt SB-TRIO/DOMINO, galv.
Bolt SB-MAXIMO, galv.
Sleeve SB-MAXIMO, galv.
Sleeve SB-MAXIMO WDMX

025760	1.300
--------	-------

Waler Connector SB-A, B, C
 For connecting Steel Walers SRZ and SRU, Profile U100 respectively U120 to SB-A0, A, B, C.

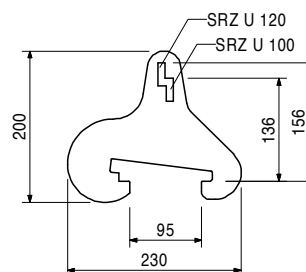
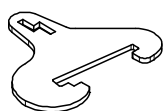

Accessories

024250	0.331
--------	-------

Wedge K, galv.

024250	0.331
--------	-------

Wedge K, galv.
 For Coupling Compression Plate KDP, Wedge Head Piece SRZ/SRU and Waler Connector SB-A, B, C.

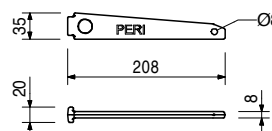

025750	28.700
--------	--------

Guide Roller SB-A, B
 For moving SB-A0, SB-A and SB-B brace frame units.

Technical Data
 Permissible load-bearing capacity 1.2 t.

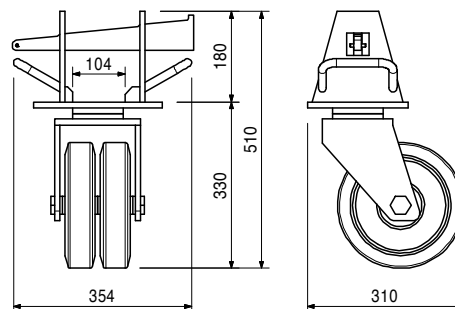
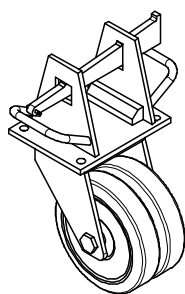

SB Brace Frame



Item no.	Weight kg
027510	365.000

Brace Frame SB-2

For forming single-sided walls and special applications.

Complete with

- 1 pc. 715121 Adjusting Unit SB-2
- 1 pc. 715110 Spindle SB-1, compl.
- 1 pc. 770012 Split Pin ISO 8752 8 x 60, galv.
- 3 pc. 017040 Screw-On Coupler AK 48, galv.

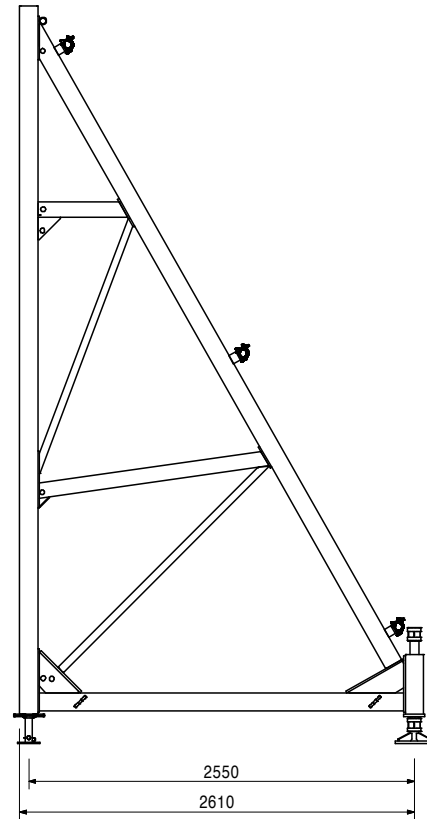
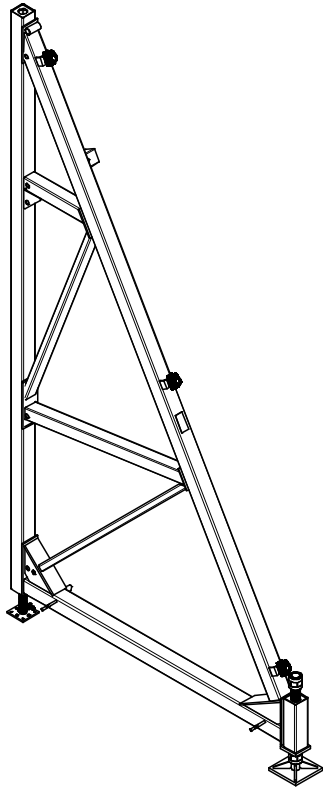

Accessories

027210	3.300
--------	-------

Spanner SW 80, for SB

027590	2.400
--------	-------

Hook Strap for SB-1, 2

For fixing Brace Frame SB-1 and SB-2 to Steel Waler SRZ and SRU Profile U100 – U140.

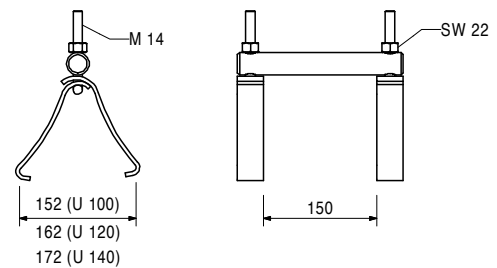
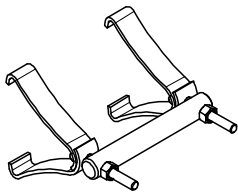

SB Brace Frame



Item no.	Weight kg
116078	3.970

Hook Strap for SB-2, asymmetric
 For fixing Brace Frame SB-2 to Steel Waler SRZ and SRU Profile U100 – U140.

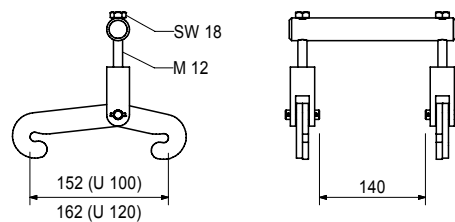
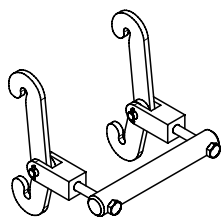

027680	49.600
--------	--------

Connector SB-1, 2 - MX/TR/D
 For assembly of Brace Frame SB-1, 2 to MAXIMO, TRIO and DOMINO Panels.

Technical Data
 Permissible load-bearing point capacity 1.0 t with crane sling angle $\leq 15^\circ$.

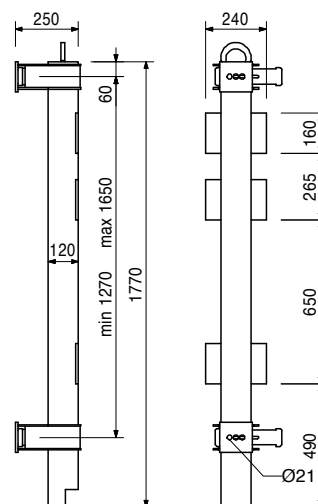
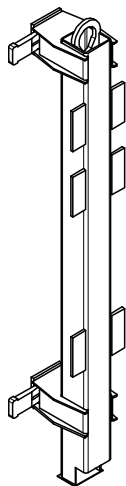

Accessories

027690	0.368	Bolt SB-TRIO/DOMINO, galv.
027590	2.400	Hook Strap for SB-1, 2
113255	0.414	Bolt SB-MAXIMO, galv.
114107	1.190	Sleeve SB-MAXIMO, galv.
114417	1.400	Sleeve SB-MAXIMO WDMX

100901	5.370
--------	-------

SB-L Tension Strut, l = 740 mm
 For Brace Frame SB-L. For forming single-sided walls.

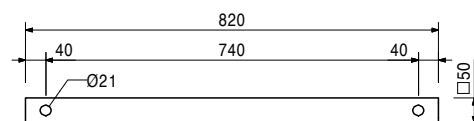
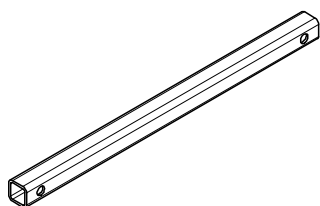

SB Brace Frame



Item no.	Weight kg
100903	12.000

SB-L Anchor Bracket

For Brace Frame SB-L. For forming single-sided walls.

Complete with

1 pc. 105400 Pin \varnothing 20 x 140, galv.
1 pc. 018060 Cotter Pin 4/1, galv.

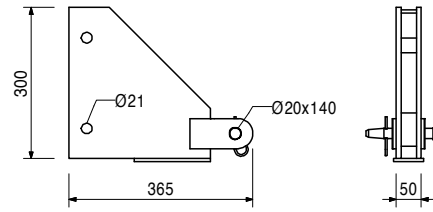
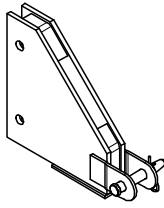

Accessories

024910	0.303
710334	0.064
024180	0.126

Bolt ISO 4014 M20 x 100-8.8, galv.
Nut ISO 4032 M20-8, galv.
Compensation Washer 20, galv.

010050	51.600
--------	--------

Steel Waler SRZ U100, l = 2.45 m

Steel waler for VARIO GT 24 panels and special applications.

Note

Special lengths and other profile sizes on request.

Technical Data

U100: $W_y = 82.4 \text{ cm}^3$, $I_y = 412 \text{ cm}^4$

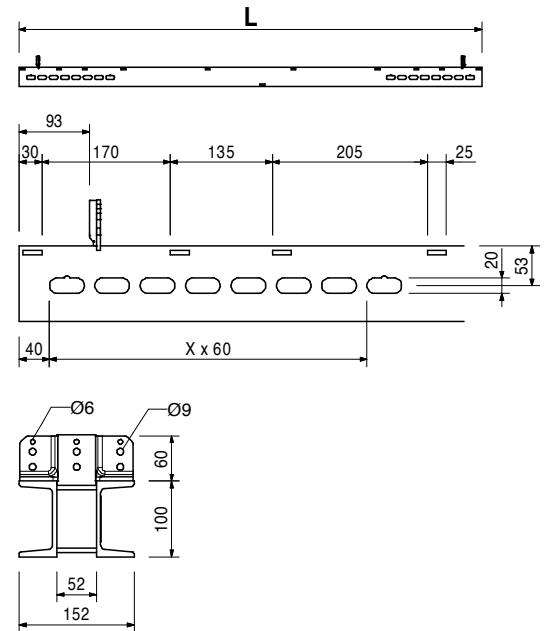
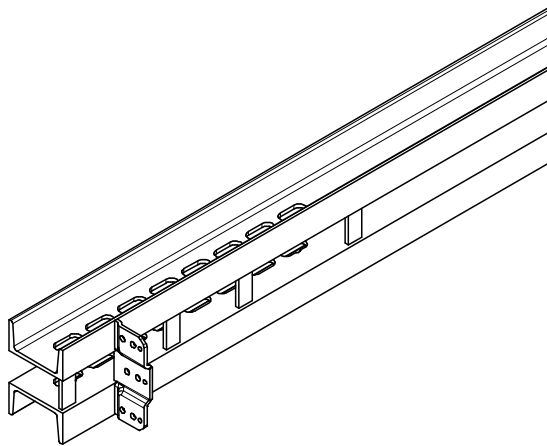

102018	4.880
--------	-------

Base Plate-2 for RS 1000/1400, galv.

For assembly of Push-Pull Props RS 210, 260, 300, 450, 650, 1000, 1400 and Heavy Duty Spindles.

Complete with

2 pc. 105400 Pin \varnothing 20 x 140, galv.
2 pc. 018060 Cotter Pin 4/1, galv.

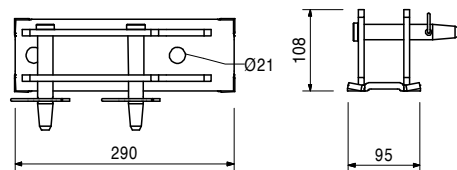
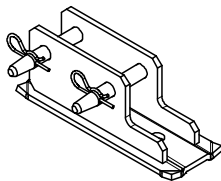

SB Brace Frame

Item no.	Weight kg
101776	24.900

Heavy Duty Spindle SLS 140/240
 As adjustable spindle in lattice frameworks with SRU Steel Walers and RCS Climbing Rails.

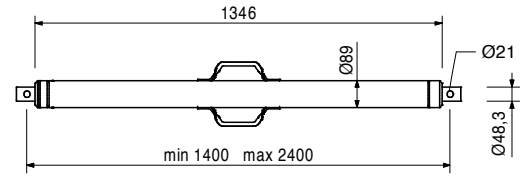
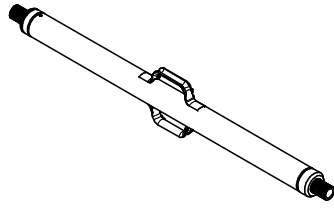

024910	0.303	Bolt ISO 4014 M20 x 100-8.8, galv.
--------	-------	---

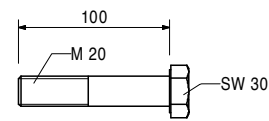
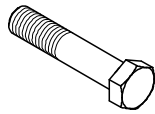

710334	0.064	Nut ISO 4032 M20-8, galv.
--------	-------	----------------------------------

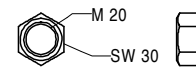

024180	0.126	Compensation Washer 20, galv.
--------	-------	--------------------------------------

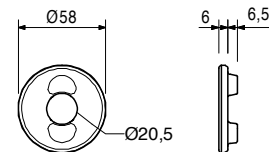

017010	1.400	Swivel Coupling SW 48/48, galv. For Scaffold Tubes Ø 48 mm.
--------	-------	---

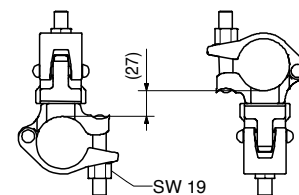
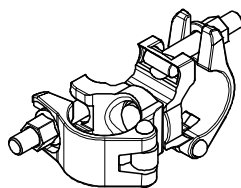

Item no.	Weight kg		L
		Scaffold Tubes Steel Ø 48.3 x 3.2	
026415	3.550	Scaff. Tube Steel Ø 48.3 x 3.2, special length	
026417	0.000	Cutting Cost Scaffold Tube	
026411	3.550	Scaff. Tube Steel Ø 48.3 x 3.2, l = 1.0 m	1000
026412	7.100	Scaff. Tube Steel Ø 48.3 x 3.2, l = 2.0 m	2000
026413	10.650	Scaff. Tube Steel Ø 48.3 x 3.2, l = 3.0 m	3000
026414	14.200	Scaff. Tube Steel Ø 48.3 x 3.2, l = 4.0 m	4000
026419	17.750	Scaff. Tube Steel Ø 48.3 x 3.2, l = 5.0 m	5000
026418	21.600	Scaff. Tube Steel Ø 48.3 x 3.2, l = 6.0 m	6000

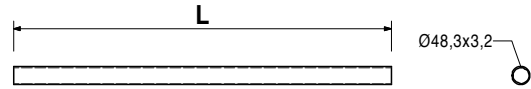
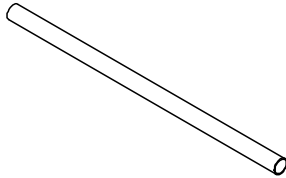

			L
		Spanners SW for SB	
027210	3.300	Spanner SW 80, for SB	645
027213	2.300	Spanner SW 70, for SB	570
027211	0.760	Spanner SW 46, for SB	380

For different applications.

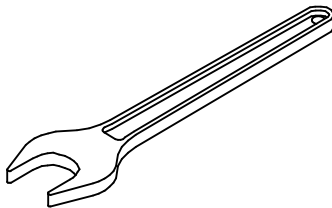

		Tie Rods DW 15	Note
030030	1.440	Tie Rod DW 15, spec. length	Non-weldable! Take official Approval into consideration!
030050	0.000	Cutting Cost Tie Rod DW 15, B 15	Technical Data
030005	0.720	Tie Rod DW 15, l = 0.50 m	Permissible tension force 90 kN.
030480	1.440	Tie Rod DW 15, l = 1.00 m	

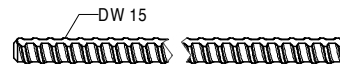
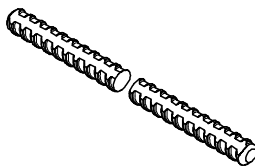

030840	0.515	Threaded Anchor Plate DW 15	Note
		For use with Tie Rod DW 15 or B 15. For anchoring in concrete.	Lost anchor part.

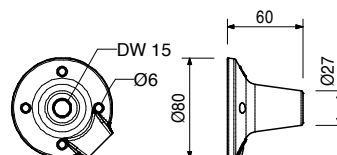

SB Brace Frame

Item no.	Weight kg
030060	2.130

Brace Frame Double Anchor DW 15

Non-weldable! Take approval into consideration!

Technical Data

Permissible load 2 x 90 kN. Dependent on concrete strength and installation depth.

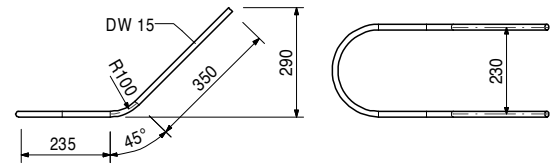
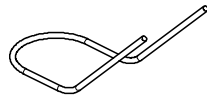

030090	0.402
--------	-------

Hex. Nut DW 15 SW 30/108, galv.

For coupling Tie Rod DW 15 and B 15.

Technical Data

Permissible load 90 kN.

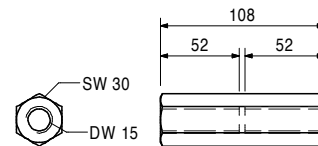
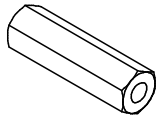

030100	0.439
--------	-------

Wingnut DW 15, galv.

For anchoring with Tie Rod DW 15 and B 15.

Technical Data

Permissible load 90 kN.

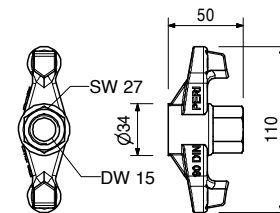

027520	7.030
--------	-------

Double Anchor Tie Yoke DSW

For anchoring with Tie Rod DW 15.

Technical Data

Permissible load 2 x 90 kN.

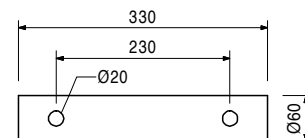
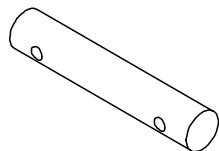

Item no.	Weight kg
031580	0.440

V-Tie Holder DW 15

For easy installation of DW 15 Tie Rods at 45° inclinations.

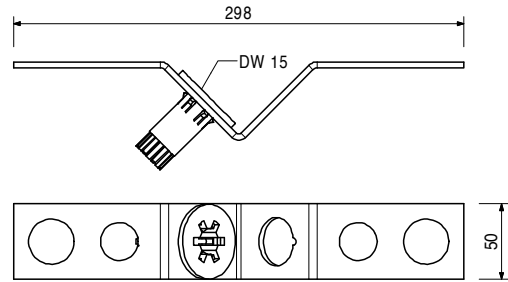
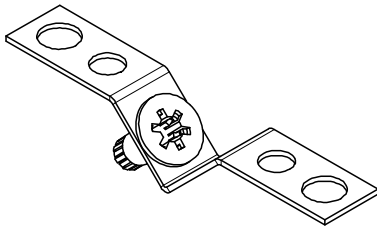

031631	0.345
--------	-------

Leading Anchor Coupler DW 15, compl.

For easy installation of DW 15 Tie Rods at 45° inclinations.

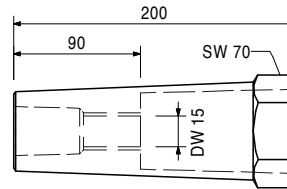
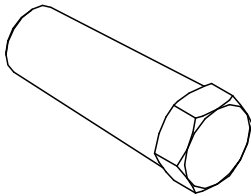

031627	0.967
--------	-------

Spacer Tube rough DR 32, l = 3.00 m

Plastic spacer tube for DW 26.

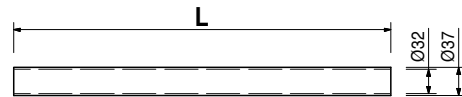
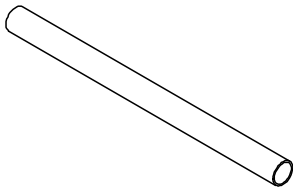

030700	2.560
030800	0.000
030640	1.280
030641	2.560

Tie Rods DW 20

Tie Rod DW 20, spec. length

Cutting Cost Tie Rod DW 20/B 20

Tie Rod DW 20, l = 0.50 m

Tie Rod DW 20, l = 1.00 m

Note

Non-weldable! Take official Approval into consideration!

Technical Data

Permissible tension force 150 kN.

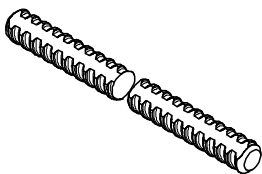

Item no. Weight kg

030860 0.792

Threaded Anchor Plate DW 20

For use with Tie Rod DW 20, B 20 or Screw-On Cone-2 M24/DW 20. For anchoring in concrete.

Note

Lost anchor part.

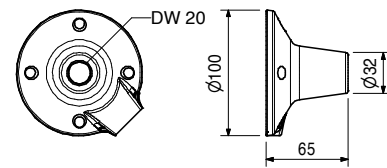
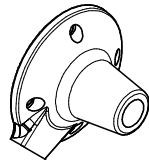

030590 0.685

Hex. Nut DW 20 SW 36/110, weldable

For coupling Tie Rod DW 20 and B 20.

Note

Weldable!

Technical Data

Permissible load 150 kN.

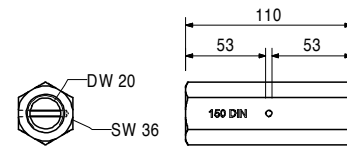
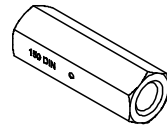

030580 0.371

Hex. Nut DW 20 SW 36/60, weldable

For anchoring with Tie Rod DW 20 and B 20.

Note

Weldable!

Technical Data

Permissible load 150 kN.

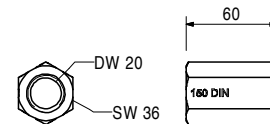
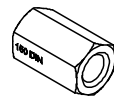

030990 0.786

Wingnut DW 20, galv.

For anchoring with Tie Rod DW 20 and B 20.

Technical Data

Permissible load 150 kN.

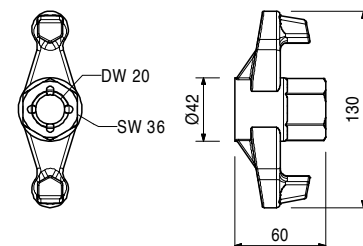

Item no.	Weight kg
030830	2.180

Counterplate DW 20, 120 x 120 x 20
For anchoring with Tie Rod DW 20 and B 20.

Technical Data
Permissible load 150 kN.

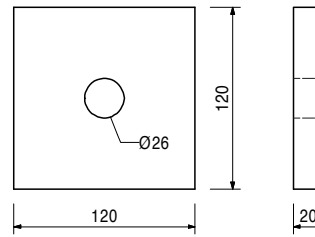
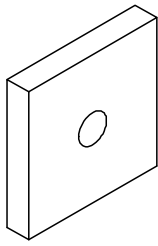

031590	0.420
--------	-------

V-Tie Holder DW 20
For easy installation of DW 20 Tie Rods at 45° inclinations.

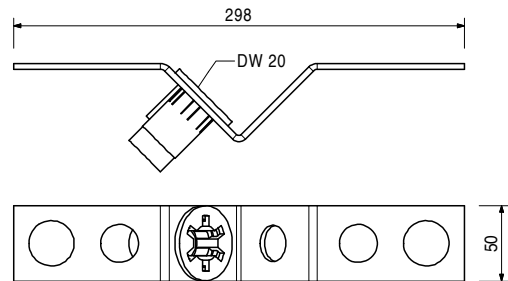
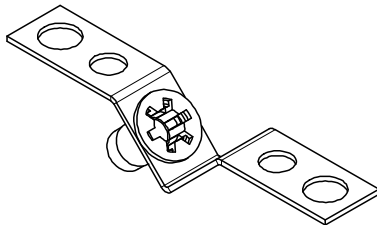

031632	0.355
--------	-------

Leading Anchor Coupler DW 20
For easy installation of DW 20 Tie Rods at 45° inclinations.

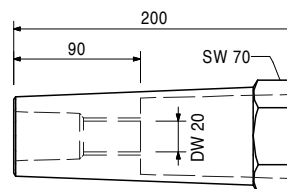
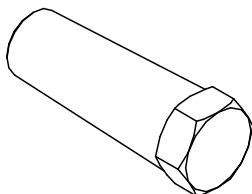

031634	1.250
--------	-------

Spacer Tube rough DR 42, l = 3.00 m
Plastic spacer tube for DW 20, 26.

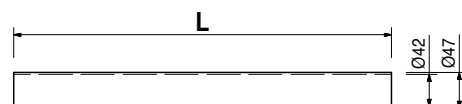
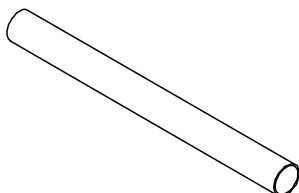

SB Brace Frame



Item no. Weight kg

		Tie Rods DW 26
030340	4.480	Tie Rod DW 26, spec. length
030500	0.000	Cutting Cost Tie Rod DW 26
030645	2.240	Tie Rod DW 26, l = 0.50 m
030646	4.480	Tie Rod DW 26, l = 1.00 m

Note

Non-weldable! Take official approval into consideration!

Technical Data

Permissible tension force 250 kN.

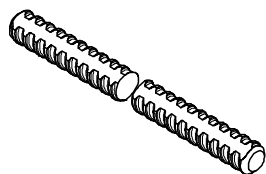

030870	1.260	Threaded Anchor Plate DW 26 For use with Tie Rod DW 26 or Screw-On Cone M36/DW 26. For anchoring in concrete.
--------	-------	---

Note

Lost anchor part.

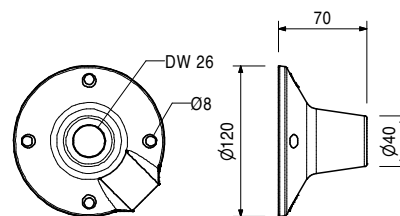
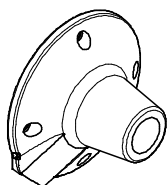

030400	2.620	Coupling Nut M 30/DW 26, galv. For coupling Tension Rod and Tie Rod DW 26.
--------	-------	--

Technical Data

Permissible load 250 kN.

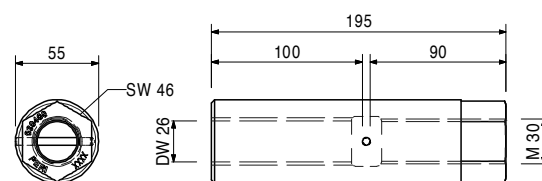
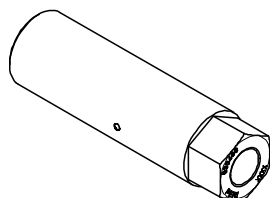

027540	5.170	Tension Rods M30 with Nut
027230	6.810	Tension Rod with Nut 100/M30 Tension Rod with Nut 135/M30 For anchoring the Brace Frame SB.

Technical Data

Permissible load 250 kN.

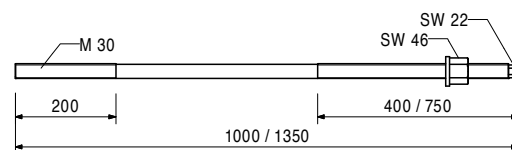
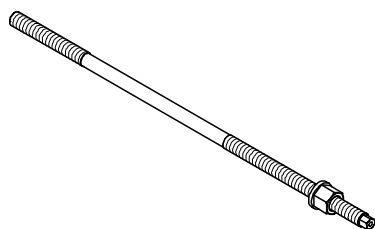

Item no.	Weight kg
030980	1.540

Hex. Coupler DW 26 SW 46/150, weldable
For coupling Tie Rod DW 26.

Note
Weldable!
Technical Data
Permissible load 250 kN.

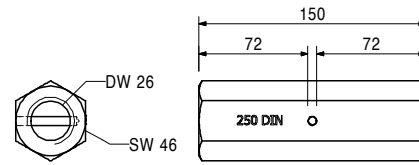
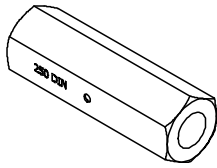

030970	0.800
--------	-------

Hex. Coupler DW 26 SW 46/80, weldable
For anchoring with Tie Rod DW 26.

Note
Weldable!
Technical Data
Permissible load 250 kN.

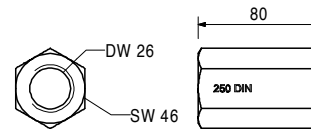
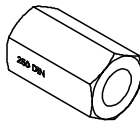

031600	0.430
--------	-------

V-Tie Holder DW 26
For easy installation of DW 26 Tie Rods at 45° inclinations.

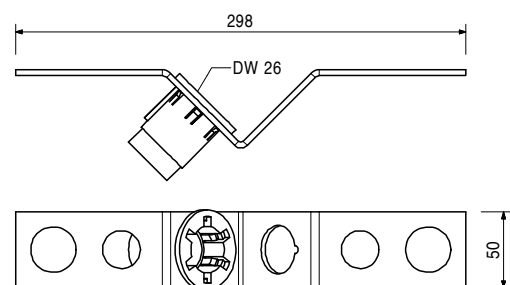

031633	0.365
--------	-------

Leading Anchor Coupler DW 26
For easy installation of DW 26 Tie Rods at 45° inclinations.

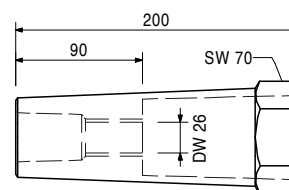

SB Brace Frame

Item no.	Weight kg
031634	1.250

Spacer Tube rough DR 42, l = 3.00 m
Plastic spacer tube for DW 20, 26.

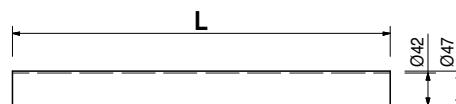
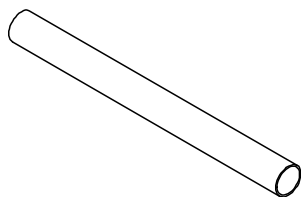

101621	10.100
--------	--------

Tension Release Plate SB DW 26
For anchoring of Brace Frame SB. Allows easy release of higher tensile loads. In connection with Anchor Waler 55 or 235. Turn bolt to working position before shuttering.

Complete with
4 pc. 724563 Hex. Bolt ISO 4017 M30 x 50-8.8, galv.
Technical Data
Permissible load 250 kN.

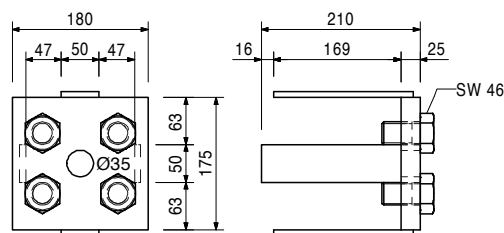
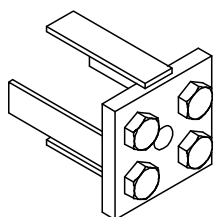

027480	7.960
--------	-------

Anchor Plate SB - DW 26
For anchoring of Brace Frame SB.

Technical Data
Permissible load 250 kN.

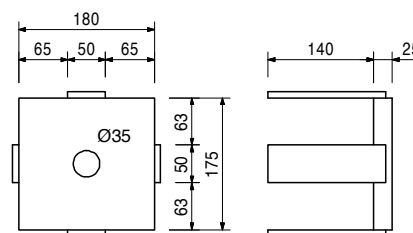
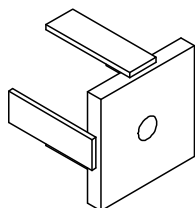

109017	11.600
--------	--------

Anchor Waler U160, l = 0.55 m
For anchoring of Brace Frame SB.

Technical Data
Permissible load 2 x 250 kN.

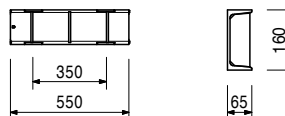
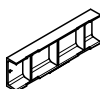

027650	9.940
--------	-------

Anchor Waler U140, l = 0.55 m
For anchoring of Brace Frame SB.

Technical Data
Permissible load 2 x 135 kN.

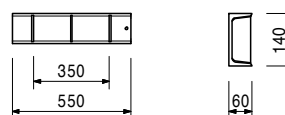
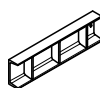

SB Brace Frame

Item no.	Weight kg
027530	39.800

Anchor Waler U140, l = 2.35 m
For anchoring of Brace Frame SB.

Technical Data
Permissible load 4 x 135 kN.

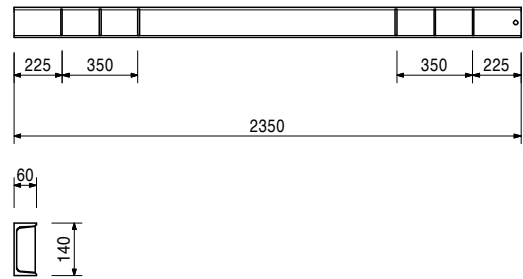
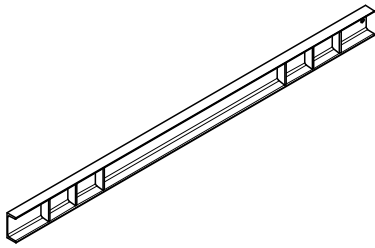

106661	31.800
--------	--------

Brace Frame Wall Scaffold Hinge
For horizontal use of PERI Brace Frames SB-A0, A, B and SB-2 as climbing brackets.

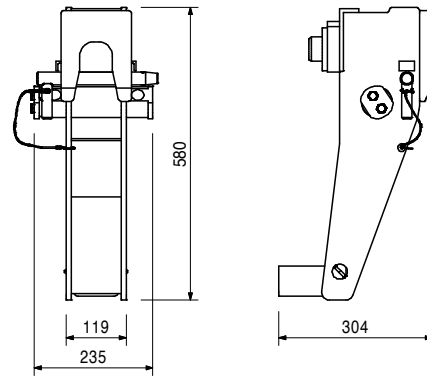
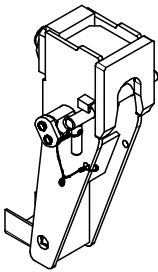

Accessories

106662	4.870
106663	13.800

Brace Frame Adaptor SB A0, A, B
Brace Frame Adaptor SB-2

106662	4.870
--------	-------

Brace Frame Adaptor SB A0, A, B
For mounting the brace frame wall scaffold hinge to the Brace Frame SB-A0, A or B.

Complete with
2 pc. 106803 Nuts ISO 7042 M24-10, galv.
2 pc. 106797 Bolt ISO 4014 M24 x 220-10.9, galv.

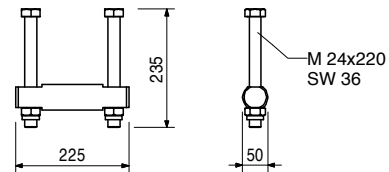
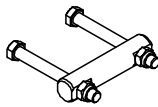

106663	13.800
--------	--------

Brace Frame Adaptor SB-2
For mounting of Brace Frame Wall Scaffold Hinge to the Brace Frame SB-2.

Complete with
2 pc. 106798 Bolt ISO 4014 M24 x 500-10.9, galv.
2 pc. 106803 Nuts ISO 7042 M24-10, galv.

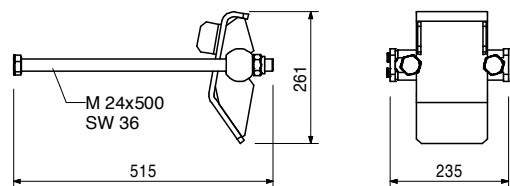
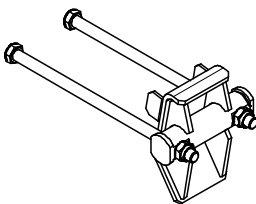

SB Brace Frame

Item no.	Weight kg
111866	64.600

Wall Scaffold Hinge SB double

For horizontal use of PERI Brace Frames SB-A0, A, B as climbing bracket.

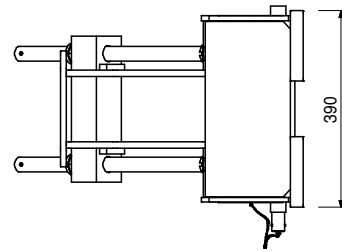
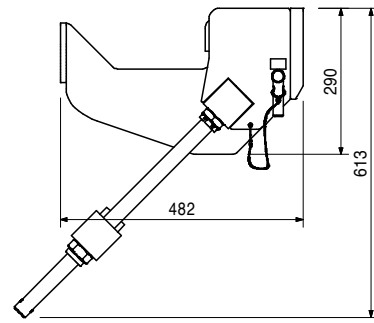
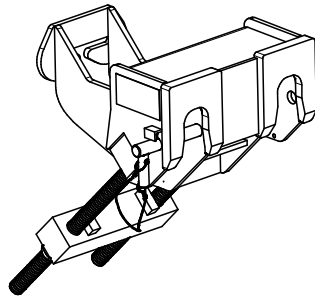

030940	3.040
--------	-------

Climbing Cone-2 M36/DW 26, galv.

Tie System M36.
For anchoring of climbing systems.

Note

Separate design information on request.

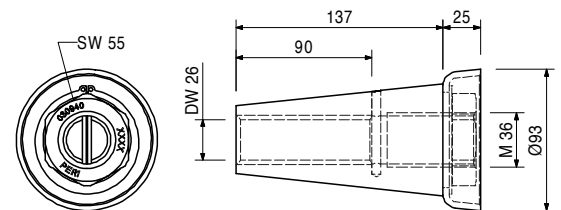
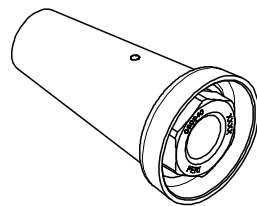

Accessories

030870	1.260
030340	4.480

Threaded Anchor Plate DW 26

Tie Rod DW 26, spec. length

029490	1.760
--------	-------

Scaffold Mounting Ring M36, galv.

Tie System M36.
For anchoring of climbing systems.

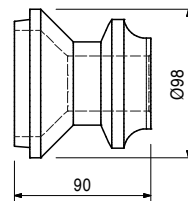
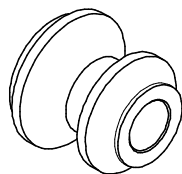

Accessories

029550	1.400
--------	-------

Bolt ISO 4014 M36 x 130-10.9, galv.

Item no.	Weight kg
030870	1.260

Threaded Anchor Plate DW 26

For use with Tie Rod DW 26 or Screw-On Cone M36/DW 26. For anchoring in concrete.

Note

Lost anchor part.

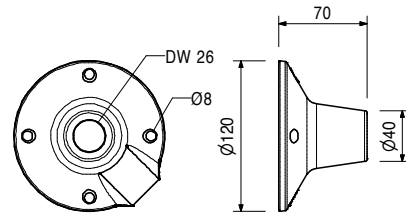
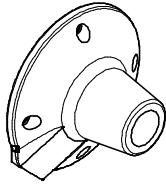

030340	4.480
030500	0.000

Tie Rod DW 26

Tie Rod DW 26, spec. length
Cutting Cost Tie Rod DW 26

Note

Non-weldable! Take official approval into consideration!

Technical Data

Permissible tension force 250 kN.

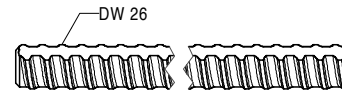
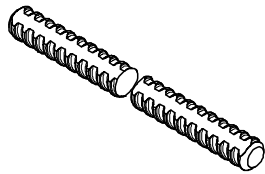

029550	1.400
--------	-------

Bolt ISO 4014 M36 x 130-10.9, galv.

High-strength bolt for anchoring of climbing systems.

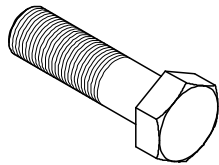
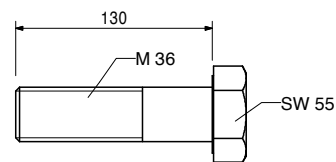

029430	0.930
--------	-------

Bolt ISO 4017 M36 x 70-8.8, galv.

Bolt for anchoring of climbing systems and as advancing bolt.

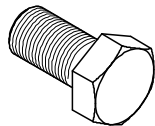
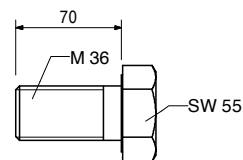

Item no.	Weight kg
029390	0.170

Anchor Positioning Plate M36, galv.

For fixing the M36 anchor system if the plywood formlining is drilled through.

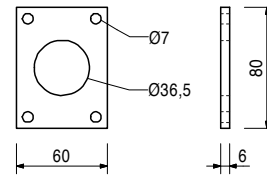
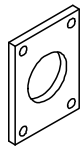

Accessories

029440	0.005
--------	-------

Lag Screw DIN 571 6 x 20, galv.

029440	0.005
--------	-------

Lag Screw DIN 571 6 x 20, galv.

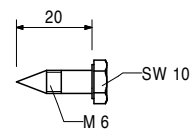

026460	0.308
--------	-------

Anchor Positioning Stud M36, galv.

For fixing the M36 anchor system if the plywood formlining is not drilled through.

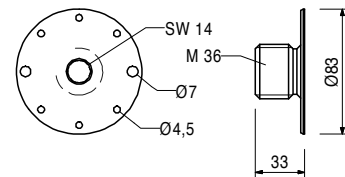
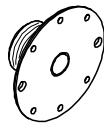

Accessories

027212	0.445
710312	0.005

Allen Key SW 14, long

Nail 3 x 80

027212	0.445
--------	-------

Allen Key SW 14, long

Fits to PERI Anchor Positioning Studs and Allen Key Bolts M16.

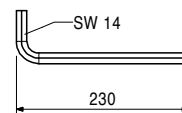

PERI International

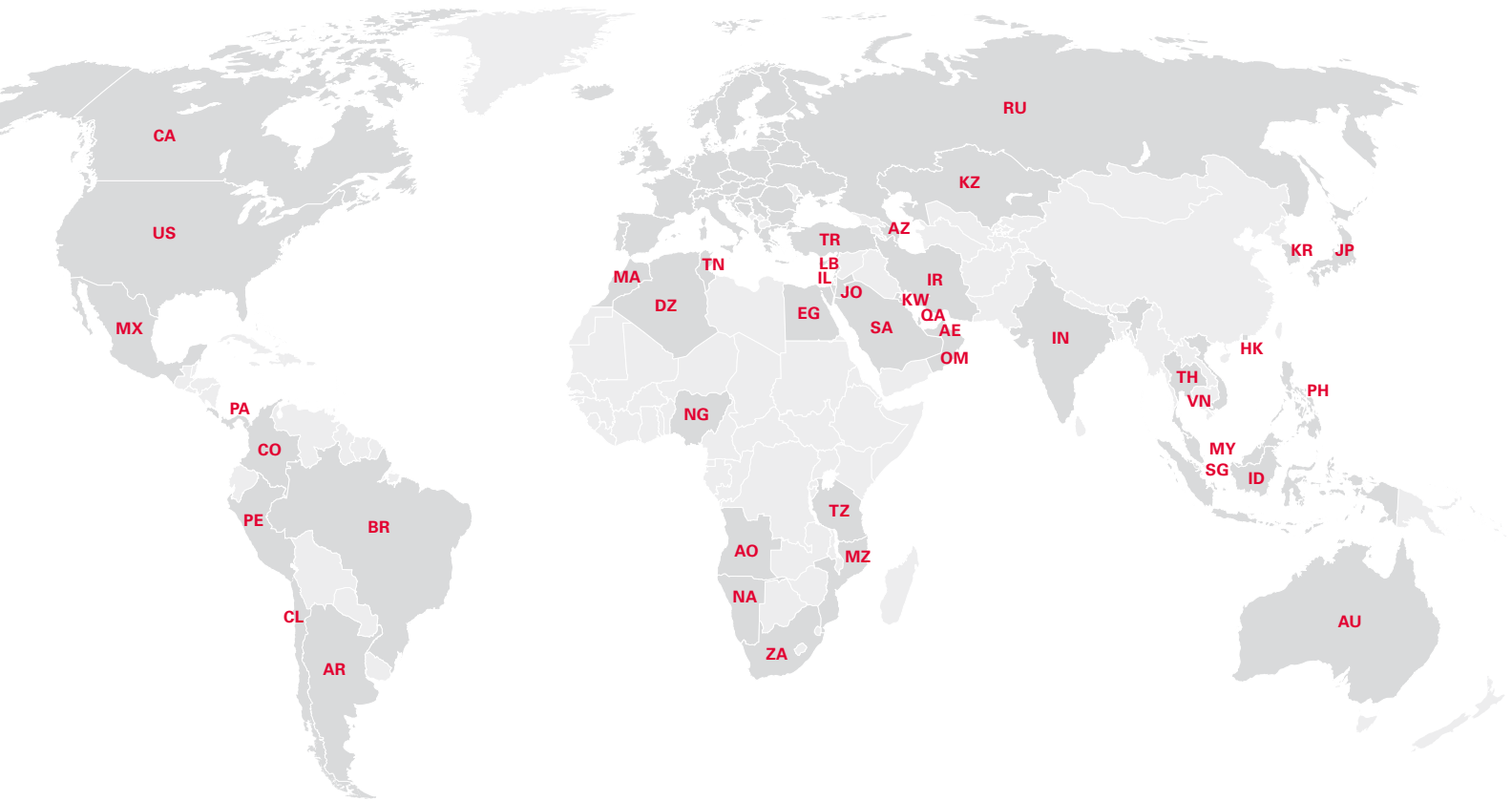

North America

- CA** Canada
PERI Formwork Systems, Inc.
www.peri.ca
- MX** Mexico
PERI Cimbras y Andamios, S.A. de C.V.
www.peri.com.mx
- PA** Panama
PERI Panama Inc.
www.peri.com.pa
- US** USA
PERI Formwork Systems, Inc.
www.peri-usa.com

South America

- AR** Argentina
PERI S.A.
www.peri.com.ar
- BR** Brazil
PERI Formas e Escoramentos Ltda.
www.peribrasil.com.br
- CL** Chile
PERI Chile Ltda.
www.peri.cl
- CO** Colombia
PERI S.A.S.
www.peri.com.co
- PE** Peru
PERI Peruana S.A.C.
www.peri.com.pe

Africa

- AO** Angola
Pericofragens, Lda.
www.peri.pt
- DZ** Algeria
S.A.R.L. PERI
www.peri.dz
- EG** Egypt
Egypt Branch Office
www.peri.com.eg
- MA** Morocco
PERI S.A.
www.peri.ma
- MZ** Mozambique
PERI (Pty.) Ltd.
www.peri.co.mz
- NA** Namibia
PERI (Pty.) Ltd.
www.peri.na
- NG** Nigeria
PERI Nigeria Ltd.
www.peri.ng
- TN** Tunisia
PERI S.A.U.
www.peri.es
- TZ** Tanzania
PERI Formwork and Scaffolding Ltd
www.peri.co.tz
- ZA** South Africa
PERI Formwork Scaffolding (Pty) Ltd
www.peri.co.za

Asia

- AE** United Arab Emirates
PERI (L.L.C.)
www.peri.ae
- AZ** Azerbaijan
PERI Representative Office
www.peri.com.tr
- HK** Hong Kong
PERI (Hong Kong) Limited
www.perihk.com
- ID** Indonesia
PT Beton Perkasa Wijaksana
www.betonperkasa.com
- IL** Israel
PERI F.E. Ltd.
www.peri.co.il
- IN** India
PERI (India) Pvt Ltd
www.peri.in
- IR** Iran
PERI Pars. Ltd.
www.peri.ir
- JO** Jordan
PERI GmbH – Jordan
www.peri.com
- JP** Japan
PERI Japan K.K.
www.peri.co.jp
- KR** Korea
PERI (Korea) Ltd.
www.perikorea.com
- KW** Kuwait
PERI Kuwait W.L.L.
www.peri.com.kw
- KZ** Kazakhstan
TOO PERI Kazakhstan
www.peri.kz
- LB** Lebanon
PERI Lebanon Sarl
lebanon@peri.de
- MY** Malaysia
PERI Formwork Malaysia Sdn. Bhd.
www.perimalaysia.com
- OM** Oman
PERI (L.L.C.)
www.peri.ae
- PH** Philippines
PERI-Asia Philippines, INC.
www.peri.com.ph
- QA** Qatar
PERI Qatar LLC
www.peri.qa
- SA** Saudi Arabia
PERI Saudi Arabia Ltd.
www.peri.com.sa
- SG** Singapore
PERI Asia Pte Ltd
www.periasia.com
- TH** Thailand
Peri (Thailand) Co., Ltd.
www.peri.co.th
- TR** Turkey
PERI Kalıp ve İskeleleri
www.peri.com.tr
- VN** Vietnam
PERI ASIA PTE LTD
www.peri.com.vn



PERI

PERI GmbH
Formwork Scaffolding Engineering
Rudolf-Diesel-Strasse 19
89264 Weissenhorn
Germany
Tel. +49 (0)7309.950-0
Fax +49 (0)7309.951-0
info@peri.com
www.peri.com

Oceania

AU Australia
PERI Australia Pty. Ltd.
www.periaus.com.au

Europe

AL Albania
PERI Kalıp ve İskeleleri
www.peri.com.tr

AT Austria
PERI Ges.mbh
www.peri.at

BA Bosnia and Herzegovina
PERI oplate i skele d.o.o
www.peri.com.hr

BE Belgium
PERI N.V.
www.peri.be

BG Bulgaria
PERI Bulgaria EOOD
www.peri.bg

BY Belorussia
IOOO PERI
www.peri.by

CH Switzerland
PERI AG
www.peri.ch

CZ Czech Republic
PERI spol. s r.o.
www.peri.cz

DE Germany
PERI GmbH
www.peri.de

DK Denmark
PERI Danmark A/S
www.peri.dk

EE Estonia
PERI AS
www.peri.ee

ES Spain
PERI S.A.U.
www.peri.es

FI Finland
PERI Suomi Ltd. Oy
www.perisuomi.fi

FR France
PERI S.A.S.
www.peri.fr

GB United Kingdom
PERI Ltd.
www.peri.ltd.uk

GR Greece
PERI Hellas Ltd.
www.perihellas.gr

HR Croatia
PERI oplate i skele d.o.o.
www.peri.com.hr

HU Hungary
PERI Kft.
www.peri.hu

IR Ireland
Siteserv Access & Formwork
www.siteservaccess.ie

IS Iceland
Armar ehf.
www.armor.is

IT Italy
PERI S.r.l.
www.peri.it

LT Lithuania
PERI UAB
www.peri.lt

LU Luxembourg
N.V. PERI S.A.
www.peri.lu

LV Latvia
PERI SIA
www.peri-latvija.lv

NL Netherlands
PERI b.v.
www.peri.nl

NO Norway
PERI Norge AS
www.peri.no

PL Poland
PERI Polska Sp. z o.o.
www.peri.com.pl

PT Portugal
Pericofragens Lda.
www.peri.pt

RO Romania
PERI România SRL
www.peri.ro

RS Serbia
PERI oplate d.o.o.
www.peri.rs

RU Russia
OOO PERI
www.peri.ru

SE Sweden
PERI Sverige AB
www.peri.se

SI Slovenia
PERI oplate i skele d.o.o
www.peri.com.hr

SK Slovakia
PERI spol. s. r.o.
www.peri.sk

UA Ukraine
TOW PERI
www.peri.ua

**The optimal System
for every Project and
every Requirement**



Wall Formwork



Column Formwork



Slab Formwork



Climbing Systems



Bridge Formwork



Tunnel Formwork



Shoring Systems



Construction Scaffold



Facade Scaffold



Industrial Scaffold



Access



Protection Scaffold



Safety Systems



**System-Independent
Accessories**



Services



PERI GmbH
Formwork Scaffolding Engineering
 Rudolf-Diesel-Strasse 19
 89264 Weissenhorn
 Germany
 Tel. +49 (0)7309.950-0
 Fax +49 (0)7309.951-0
 info@peri.com
 www.peri.com

